

Basic Graph Algorithms

(Based on [Manber 1989])

Yih-Kuen Tsay

Department of Information Management
National Taiwan University

The Königsberg Bridges Problem

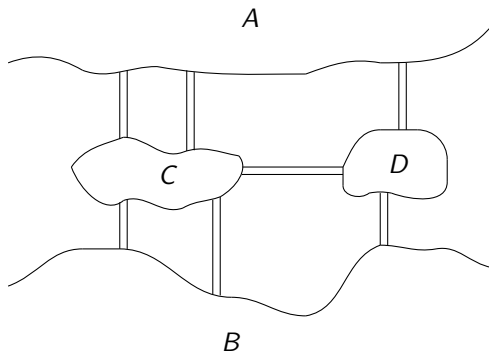

Figure: The Königsberg bridges problem.

Source: redrawn from [Manber 1989, Figure 7.1].

Can one start from one of the lands, cross every bridge exactly once, and return to the origin?

The Königsberg Bridges Problem (cont.)

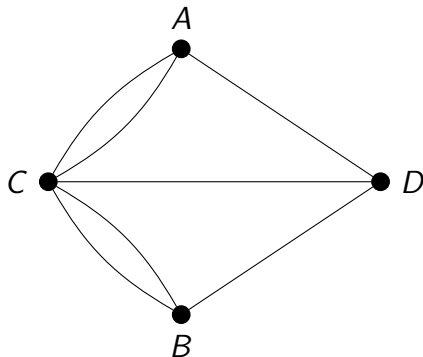

Figure: The graph corresponding to the Königsberg bridges problem.

Source: redrawn from [Manber 1989, Figure 7.2].

Graphs



- 🌐 A graph consists of a set of **vertices** (or nodes) and a set of **edges** (or links, each normally connecting two vertices).
- 🌐 A graph is commonly denoted as $G(V, E)$, where
 - ☀ G is the name of the graph,
 - ☀ V is the set of vertices, and
 - ☀ E is the set of edges.

Graphs (cont.)



- 🌐 Undirected vs. Directed Graph
- 🌐 Simple Graph vs. Multigraph
- 🌐 Path, Simple Path, Trail
- 🌐 Circuit, Cycle
- 🌐 Degree, In-Degree, Out-Degree
- 🌐 Connected Graph, Connected Components
- 🌐 Tree, Forest
- 🌐 Subgraph, Induced Subgraph
- 🌐 Spanning Tree, Spanning Forest
- 🌐 Weighted Graph

Modeling with Graphs



Reachability

-  Finding program errors
-  Solving sliding tile puzzles

Shortest Paths

-  Finding the fastest route to a place
-  Routing messages in networks

Graph Coloring

-  Coloring maps
-  Scheduling classes

Eulerian Graphs

Problem

Given an undirected connected graph $G = (V, E)$ such that all the vertices have *even degrees*, find a circuit P such that each edge of E appears in P exactly once.

The circuit P in the problem statement is called an *Eulerian circuit*.

Theorem

An undirected connected graph has an Eulerian circuit *if and only if* all of its vertices have even degrees.

Depth-First Search

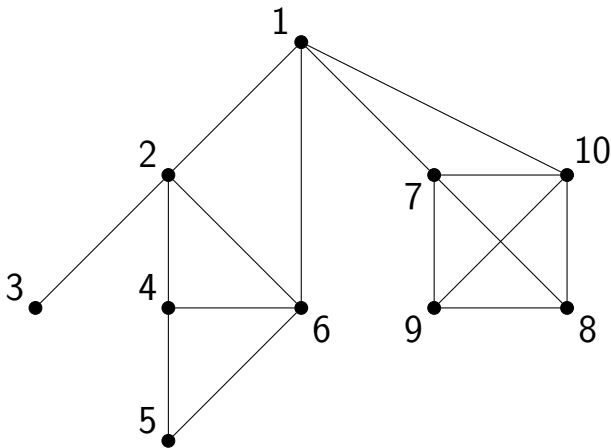

Figure: A DFS for an undirected graph.

Source: redrawn from [Manber 1989, Figure 7.4].

Depth-First Search (cont.)

```
Algorithm Depth_First_Search( $G, v$ );  
begin  
    mark  $v$ ;  
    perform preWORK on  $v$ ;  
    for all edges  $(v, w)$  do  
        if  $w$  is unmarked then  
            Depth_First_Search( $G, w$ );  
        perform postWORK for  $(v, w)$   
end
```

Depth-First Search (cont.)

```
Algorithm Refined_DFS( $G, v$ );  
begin  
  mark  $v$ ;  
  perform preWORK on  $v$ ;  
  for all edges  $(v, w)$  do  
    if  $w$  is unmarked then  
      Refined_DFS( $G, w$ );  
      perform postWORK for  $(v, w)$ ;  
  perform postWORK_II on  $v$   
end
```

Connected Components

Algorithm Connected_Components(G);

begin

Component_Number := 1;

while there is an unmarked vertex v **do**

Depth_First_Search(G, v)

(preWORK:

v.Component := *Component_Number*);

Component_Number := *Component_Number* + 1

end

Connected Components

Algorithm Connected_Components(G);

begin

Component_Number := 1;

while there is an unmarked vertex v **do**

Depth_First_Search(G, v)

(preWORK:

v.Component := *Component_Number*);

Component_Number := *Component_Number* + 1

end

Time complexity:

Connected Components

Algorithm Connected_Components(G);

begin

Component_Number := 1;

while there is an unmarked vertex v **do**

Depth_First_Search(G, v)

(preWORK:

v.Component := *Component_Number*);

Component_Number := *Component_Number* + 1

end

Time complexity: $O(|E| + |V|)$.

DFS Numbers

Algorithm DFS_Numbering(G, v);

begin

DFS_Number := 1;

Depth_First_Search(G, v)

(preWORK:

$v.DFS := DFS_Number$;

$DFS_Number := DFS_Number + 1$)

end

DFS Numbers

Algorithm DFS_Numbering(G, v);

begin

DFS_Number := 1;

Depth_First_Search(G, v)

(preWORK:

v.DFS := *DFS_Number*;

DFS_Number := *DFS_Number* + 1)

end

Time complexity: $O(|E|)$ (assuming the input graph is connected).

The DFS Tree

```
Algorithm Build_DFS_Tree( $G, v$ );  
begin  
    Depth_First_Search( $G, v$ )  
    (postWORK:  
        if  $w$  was unmarked then  
            add the edge  $(v, w)$  to  $T$ );  
end
```

The DFS Tree (cont.)

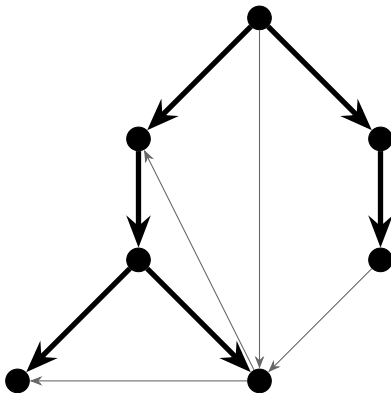

Figure: A DFS tree for a directed graph.

Source: redrawn from [Manber 1989, Figure 7.9].

The DFS Tree (cont.)

Lemma (7.2)

For an undirected graph $G = (V, E)$, every edge $e \in E$ either belongs to the DFS tree T , or connects two vertices of G , one of which is the ancestor of the other in T .

For undirected graphs, DFS avoids **cross edges**.

Lemma (7.3)

For a directed graph $G = (V, E)$, if (v, w) is an edge in E such that $v.DFS_Number < w.DFS_Number$, then w is a descendant of v in the DFS tree T .

For directed graphs, cross edges must go “**from right to left**”.

Directed Cycles

Problem

Given a directed graph $G = (V, E)$, determine whether it contains a (directed) cycle.

Lemma (7.4)

G contains a directed cycle if and only if G contains a *back edge* (relative to the DFS tree).

Directed Cycles (cont.)

```
Algorithm Find_a_Cycle( $G$ );  
begin  
   $Depth\_First\_Search(G, v)$  /* arbitrary  $v$  */  
  (preWORK:  
     $v.on\_the\_path := true$ ;  
  postWORK:  
    if  $w.on\_the\_path$  then  
       $Find\_a\_Cycle := true$ ;  
      halt;  
    if  $w$  is the last vertex on  $v$ 's list then  
       $v.on\_the\_path := false$ );  
end
```

Directed Cycles (cont.)

Algorithm Refined_Find_a_Cycle(G);

begin

Refined_DFS(G, v) /* arbitrary v */

(preWORK:

v.on_the_path := true;

postWORK:

if *w.on_the_path* **then**

Refined_Find_a_Cycle := true;

halt;

postWORK_II:

v.on_the_path := false)

end

Breadth-First Search

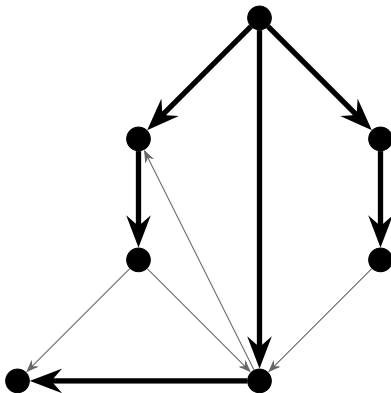

Figure: A BFS tree for a directed graph.

Source: redrawn from [Manber 1989, Figure 7.12].

Breadth-First Search (cont.)

```
Algorithm Breadth_First_Search( $G, v$ );  
begin  
  mark  $v$ ;  
  put  $v$  in a queue;  
  while the queue is not empty do  
    remove vertex  $w$  from the queue;  
    perform preWORK on  $w$ ;  
    for all edges  $(w, x)$  with  $x$  unmarked do  
      mark  $x$ ;  
      add  $(w, x)$  to the BFS tree  $T$ ;  
      put  $x$  in the queue  
end
```

Breadth-First Search (cont.)

Lemma (7.5)

If an edge (u, w) belongs to a BFS tree such that u is a parent of w , then u has the minimal BFS number among vertices with edges leading to w .

Lemma (7.6)

For each vertex w , the path from the root to w in T is a shortest path from the root to w in G .

Lemma (7.7)

If an edge (v, w) in E does not belong to T and w is on a larger level, then the level numbers of w and v differ by at most 1.

Breadth-First Search (cont.)

Algorithm Simple_BFS(G, v);

begin

put v in *Queue*;

while *Queue* is not empty **do**

remove vertex w from *Queue*;

if w is unmarked **then**

mark w ;

perform **preWORK** on w ;

for all edges (w, x) with x unmarked **do**

put x in *Queue*

end

Breadth-First Search (cont.)

Algorithm Simple_Nonrecursive_DFS(G, v);

begin

push v to *Stack*;

while *Stack* is not empty **do**

pop vertex w from *Stack*;

if w is unmarked **then**

mark w ;

perform **preWORK** on w ;

for all edges (w, x) with x unmarked **do**

push x to *Stack*

end

Topological Sorting

Problem

Given a directed acyclic graph $G = (V, E)$ with n vertices, label the vertices from 1 to n such that, if v is labeled k , then all vertices that can be reached from v by a directed path are labeled with labels $> k$.

Lemma (7.8)

A directed acyclic graph always contains a vertex with indegree 0.

Topological Sorting (cont.)

Algorithm Topological_Sorting(G);

initialize $v.indegree$ for all vertices; /* by DFS */

$G_label := 0$;

for $i := 1$ to n **do**

if $v_i.indegree = 0$ **then** put v_i in *Queue*;

repeat

 remove vertex v from *Queue*;

$G_label := G_label + 1$;

$v.label := G_label$;

for all edges (v, w) **do**

$w.indegree := w.indegree - 1$;

if $w.indegree = 0$ **then** put w in *Queue*

until *Queue* is empty

Problem

Given a directed graph $G = (V, E)$ and a vertex v , find shortest paths from v to all other vertices of G .

Shorted Paths: The Acyclic Case

Algorithm Acyclic_Shortest_Paths(G, v, n);
{Initially, $w.SP = \infty$, for every node w .}
{A topological sort has been performed on G, \dots }

begin
 let z be the vertex labeled n ;
 if $z \neq v$ **then**
 Acyclic_Shortest_Paths($G - z, v, n - 1$);
 for all w such that $(w, z) \in E$ **do**
 if $w.SP + \text{length}(w, z) < z.SP$ **then**
 $z.SP := w.SP + \text{length}(w, z)$
 else $v.SP := 0$
end

The Acyclic Case (cont.)

```
Algorithm Imp_Acyclic_Shortest_Paths( $G, v$ );  
  for all vertices  $w$  do  $w.SP := \infty$ ;  
  initialize  $v.indegree$  for all vertices;  
  for  $i := 1$  to  $n$  do  
    if  $v_i.indegree = 0$  then put  $v_i$  in Queue;  
   $v.SP := 0$ ;  
  repeat  
    remove vertex  $w$  from Queue;  
    for all edges  $(w, z)$  do  
      if  $w.SP + length(w, z) < z.SP$  then  
         $z.SP := w.SP + length(w, z)$ ;  
         $z.indegree := z.indegree - 1$ ;  
        if  $z.indegree = 0$  then put  $z$  in Queue  
  until Queue is empty
```

Shortest Paths: The General Case

```
Algorithm Single_Source_Shortest_Paths( $G, v$ );  
// Dijkstra's algorithm  
begin  
  for all vertices  $w$  do  
     $w.mark := false$ ;  
     $w.SP := \infty$ ;  
 $v.SP := 0$ ;  
  while there exists an unmarked vertex do  
    let  $w$  be an unmarked vertex s.t.  $w.SP$  is minimal;  
     $w.mark := true$ ;  
    for all edges  $(w, z)$  such that  $z$  is unmarked do  
      if  $w.SP + length(w, z) < z.SP$  then  
         $z.SP := w.SP + length(w, z)$   
end
```

Shortest Paths: The General Case

```
Algorithm Single_Source_Shortest_Paths( $G, v$ );  
// Dijkstra's algorithm  
begin  
  for all vertices  $w$  do  
     $w.mark := false$ ;  
     $w.SP := \infty$ ;  
 $v.SP := 0$ ;  
  while there exists an unmarked vertex do  
    let  $w$  be an unmarked vertex s.t.  $w.SP$  is minimal;  
     $w.mark := true$ ;  
    for all edges  $(w, z)$  such that  $z$  is unmarked do  
      if  $w.SP + length(w, z) < z.SP$  then  
         $z.SP := w.SP + length(w, z)$   
end
```

Time complexity:

Shortest Paths: The General Case

Algorithm Single_Source_Shortest_Paths(G, v);

// Dijkstra's algorithm

begin

for all vertices w **do**

$w.mark := false$;

$w.SP := \infty$;

$v.SP := 0$;

while there exists an unmarked vertex **do**

let w be an unmarked vertex s.t. $w.SP$ is minimal;

$w.mark := true$;

for all edges (w, z) such that z is unmarked **do**

if $w.SP + length(w, z) < z.SP$ **then**

$z.SP := w.SP + length(w, z)$

end

Time complexity: $O((|E| + |V|) \log |V|)$ (using a min heap).

The General Case (cont.)

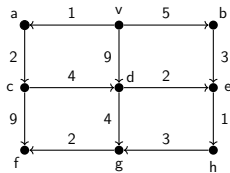

| | v | a | b | c | d | e | f | g | h |
|---|---|---|---|----------|---|----------|----------|----------|----------|
| a | 0 | 1 | 5 | ∞ | 9 | ∞ | ∞ | ∞ | ∞ |
| c | 0 | ① | 5 | 3 | 9 | ∞ | ∞ | ∞ | ∞ |
| b | 0 | ① | 5 | ③ | 7 | ∞ | 12 | ∞ | ∞ |
| d | 0 | ① | ⑤ | ③ | 7 | 8 | 12 | ∞ | ∞ |
| e | 0 | ① | ⑤ | ③ | ⑦ | 8 | 12 | ∞ | ∞ |
| h | 0 | ① | ⑤ | ③ | ⑦ | ⑧ | 12 | 11 | 9 |
| g | 0 | ① | ⑤ | ③ | ⑦ | ⑧ | 12 | 11 | ⑨ |
| f | 0 | ① | ⑤ | ③ | ⑦ | ⑧ | 12 | ⑪ | ⑨ |

Figure: An example of the single-source shortest-paths algorithm.

Source: redrawn from [Manber 1989, Figure 7.18].

Minimum-Weight Spanning Trees

Problem

Given an undirected connected weighted graph $G = (V, E)$, find a spanning tree T of G of minimum weight.

Theorem

Let V_1 and V_2 be a partition of V and $E(V_1, V_2)$ be the set of edges connecting nodes in V_1 to nodes in V_2 . The *edge with the minimum weight in $E(V_1, V_2)$* must be in the minimum-cost spanning tree of G .

Minimum-Weight Spanning Trees (cont.)

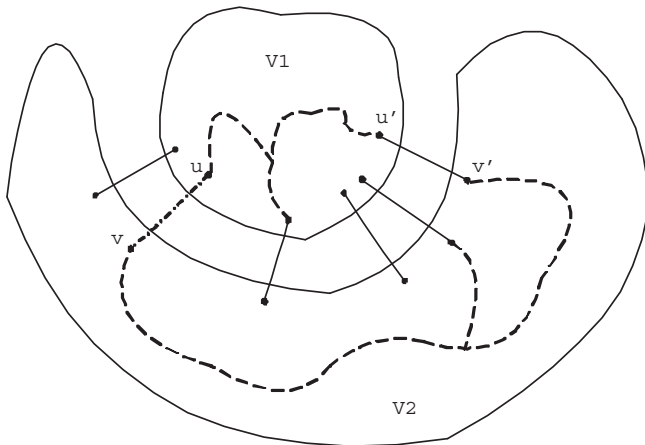

If $cost(u, v)$ is the smallest among $E(V_1, V_2)$, then $\{u, v\}$ must be in the minimum spanning tree.

Minimum-Weight Spanning Trees (cont.)

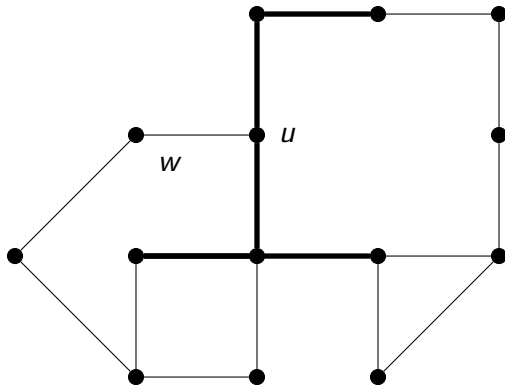

Figure: Finding the next edge of the MCST.

Source: redrawn from [Manber 1989, Figure 7.19].

Minimum-Weight Spanning Trees (cont.)

Algorithm MST(G);

// A variant of Prim's algorithm

begin

initially T is the empty set;

for all vertices w **do**

$w.mark := false$; $w.cost := \infty$;

let (x, y) be a minimum cost edge in G ;

$x.mark := true$;

for all edges (x, z) **do**

$z.edge := (x, z)$; $z.cost := cost(x, z)$;

Minimum-Weight Spanning Trees (cont.)



```
while there exists an unmarked vertex do
  let  $w$  be an unmarked vertex with minimal  $w.cost$ ;
  if  $w.cost = \infty$  then
    print "G is not connected"; halt
  else
     $w.mark := true$ ;
    add  $w.edge$  to  $T$ ;
    for all edges  $(w, z)$  do
      if not  $z.mark$  then
        if  $cost(w, z) < z.cost$  then
           $z.edge := (w, z)$ ;  $z.cost := cost(w, z)$ 
end
```

Minimum-Weight Spanning Trees (cont.)

Algorithm Another_MST(G);

// Prim's algorithm

begin

initially T is the empty set;

for all vertices w **do**

$w.mark := false$; $w.cost := \infty$;

$x.mark := true$; /* x is an arbitrary vertex */

for all edges (x, z) **do**

$z.edge := (x, z)$; $z.cost := cost(x, z)$;

Minimum-Weight Spanning Trees (cont.)

```
while there exists an unmarked vertex do  
  let  $w$  be an unmarked vertex with minimal  $w.cost$ ;  
  if  $w.cost = \infty$  then  
    print "G is not connected"; halt  
  else  
     $w.mark := true$ ;  
    add  $w.edge$  to  $T$ ;  
    for all edges  $(w, z)$  do  
      if not  $z.mark$  then  
        if  $cost(w, z) < z.cost$  then  
           $z.edge := (w, z)$ ;  
           $z.cost := cost(w, z)$   
end
```

Minimum-Weight Spanning Trees (cont.)

```
while there exists an unmarked vertex do  
  let  $w$  be an unmarked vertex with minimal  $w.cost$ ;  
  if  $w.cost = \infty$  then  
    print "G is not connected"; halt  
  else  
     $w.mark := true$ ;  
    add  $w.edge$  to  $T$ ;  
    for all edges  $(w, z)$  do  
      if not  $z.mark$  then  
        if  $cost(w, z) < z.cost$  then  
           $z.edge := (w, z)$ ;  
           $z.cost := cost(w, z)$   
    end  
end
```

Time complexity:

Minimum-Weight Spanning Trees (cont.)

```
while there exists an unmarked vertex do  
  let  $w$  be an unmarked vertex with minimal  $w.cost$ ;  
  if  $w.cost = \infty$  then  
    print "G is not connected"; halt  
  else  
     $w.mark := true$ ;  
    add  $w.edge$  to  $T$ ;  
    for all edges  $(w, z)$  do  
      if not  $z.mark$  then  
        if  $cost(w, z) < z.cost$  then  
           $z.edge := (w, z)$ ;  
           $z.cost := cost(w, z)$   
    end  
end
```

Time complexity: same as that of Dijkstra's algorithm.

Minimum-Weight Spanning Trees (cont.)

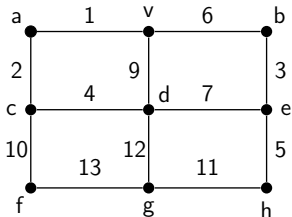

| | v | a | b | c | d | e | f | g | h |
|---|---|------|------|----------|------|----------|----------|----------|----------|
| v | - | v(1) | v(6) | ∞ | v(9) | ∞ | ∞ | ∞ | ∞ |
| a | - | - | v(6) | a(2) | v(9) | ∞ | ∞ | ∞ | ∞ |
| c | - | - | v(6) | - | c(4) | ∞ | c(10) | ∞ | ∞ |
| d | - | - | v(6) | - | - | d(7) | c(10) | d(12) | ∞ |
| b | - | - | - | - | - | b(3) | c(10) | d(12) | ∞ |
| e | - | - | - | - | - | - | c(10) | d(12) | e(5) |
| h | - | - | - | - | - | - | c(10) | h(11) | - |
| f | - | - | - | - | - | - | - | h(11) | - |
| g | - | - | - | - | - | - | - | - | - |

Figure: An example of the minimum-cost spanning-tree algorithm.

Source: redrawn from [Manber 1989, Figure 7.21].

All Shortest Paths

Problem

Given a weighted graph $G = (V, E)$ (directed or undirected) with nonnegative weights, find the minimum-length paths between all pairs of vertices.

Floyd's Algorithm

Algorithm All_Pairs_Shortest_Paths(W);

begin

 {initialization}

for $i := 1$ to n **do**

for $j := 1$ to n **do**

if $(i, j) \in E$ **then** $W[i, j] := \text{length}(i, j)$

else $W[i, j] := \infty$;

for $i := 1$ to n **do** $W[i, i] := 0$;

for $m := 1$ to n **do** {the induction sequence}

for $x := 1$ to n **do**

for $y := 1$ to n **do**

if $W[x, m] + W[m, y] < W[x, y]$ **then**

$W[x, y] := W[x, m] + W[m, y]$

end

Transitive Closure

Problem

Given a directed graph $G = (V, E)$, find its transitive closure.

```
Algorithm Transitive_Closure( $A$ );  
begin  
    {initialization omitted}  
    for  $m := 1$  to  $n$  do  
        for  $x := 1$  to  $n$  do  
            for  $y := 1$  to  $n$  do  
                if  $A[x, m]$  and  $A[m, y]$  then  
                     $A[x, y] := true$   
end
```

Transitive Closure (cont.)

Algorithm Improved_Transitive_Closure(A);

begin

{initialization omitted}

for $m := 1$ to n **do**

for $x := 1$ to n **do**

if $A[x, m]$ **then**

for $y := 1$ to n **do**

if $A[m, y]$ **then**

$A[x, y] := true$

end