

UML Diagrams

(Based on [Booch *et al.* 2005])

Yih-Kuen Tsay

Dept. of Information Management

National Taiwan University

Outline

- Structural Diagrams
- Behavioral Diagrams
- Advanced Structural Modeling
 - Object Diagrams
 - Components
- Advanced Behavioral Modeling
 - State Machines
 - Processes and Threads
 - Timing Constraints

Class Diagram

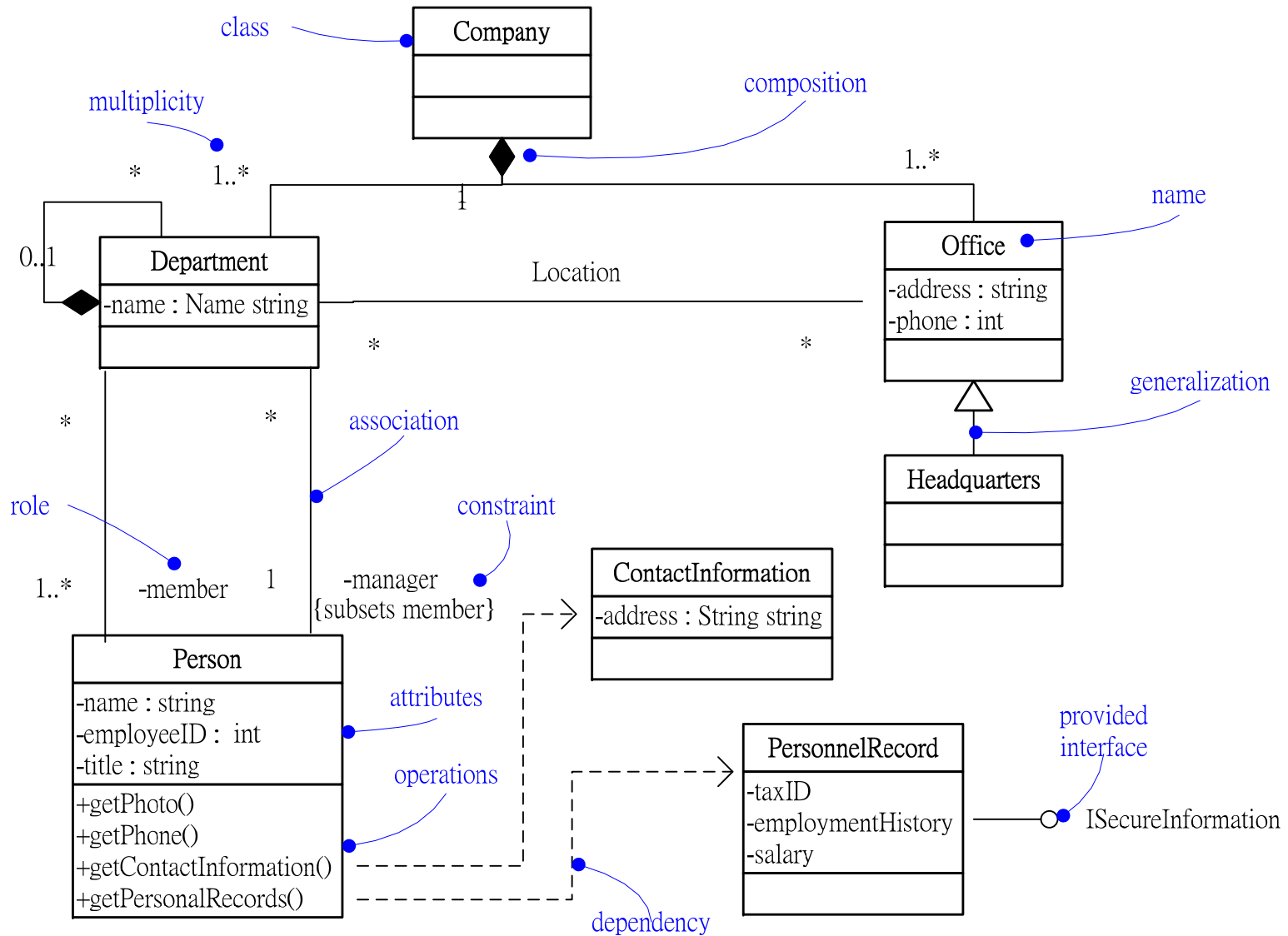

Advanced Classes

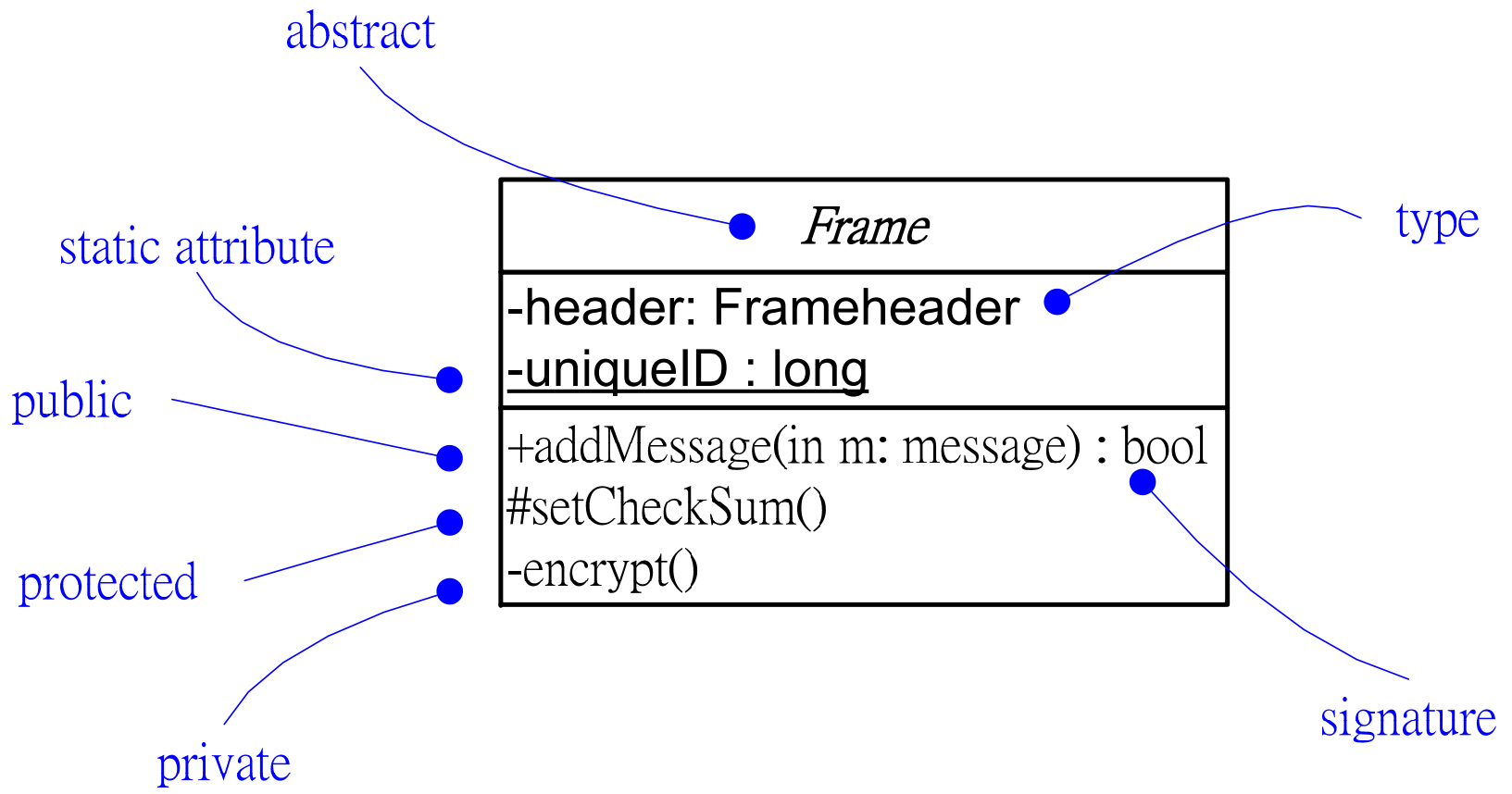

Classifiers

In general, those modeling elements that can have instances are called classifiers.

- Interface
- Datatype
- Signal
- Component
- Node
- Use case
- Subsystem

Abstract and Concrete Classes

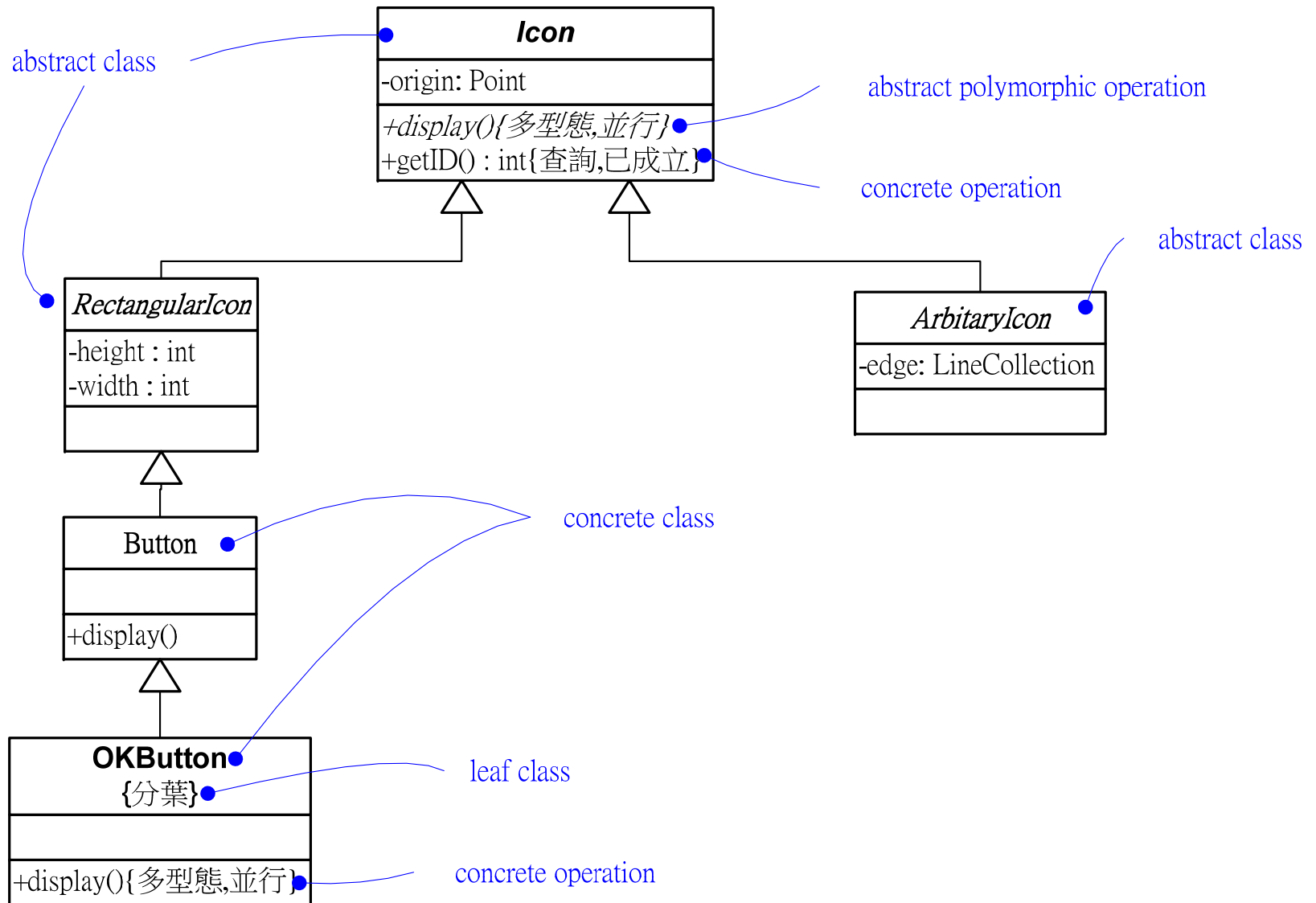

Properties on Operations

- **query**: no side effects
- **sequential**: relying on the callers to do the coordination
- **guarded**: all calls sequentialized (by the object)
- **concurrent**: concurrency control enforced
- **static**: like a global procedure

Template Classes

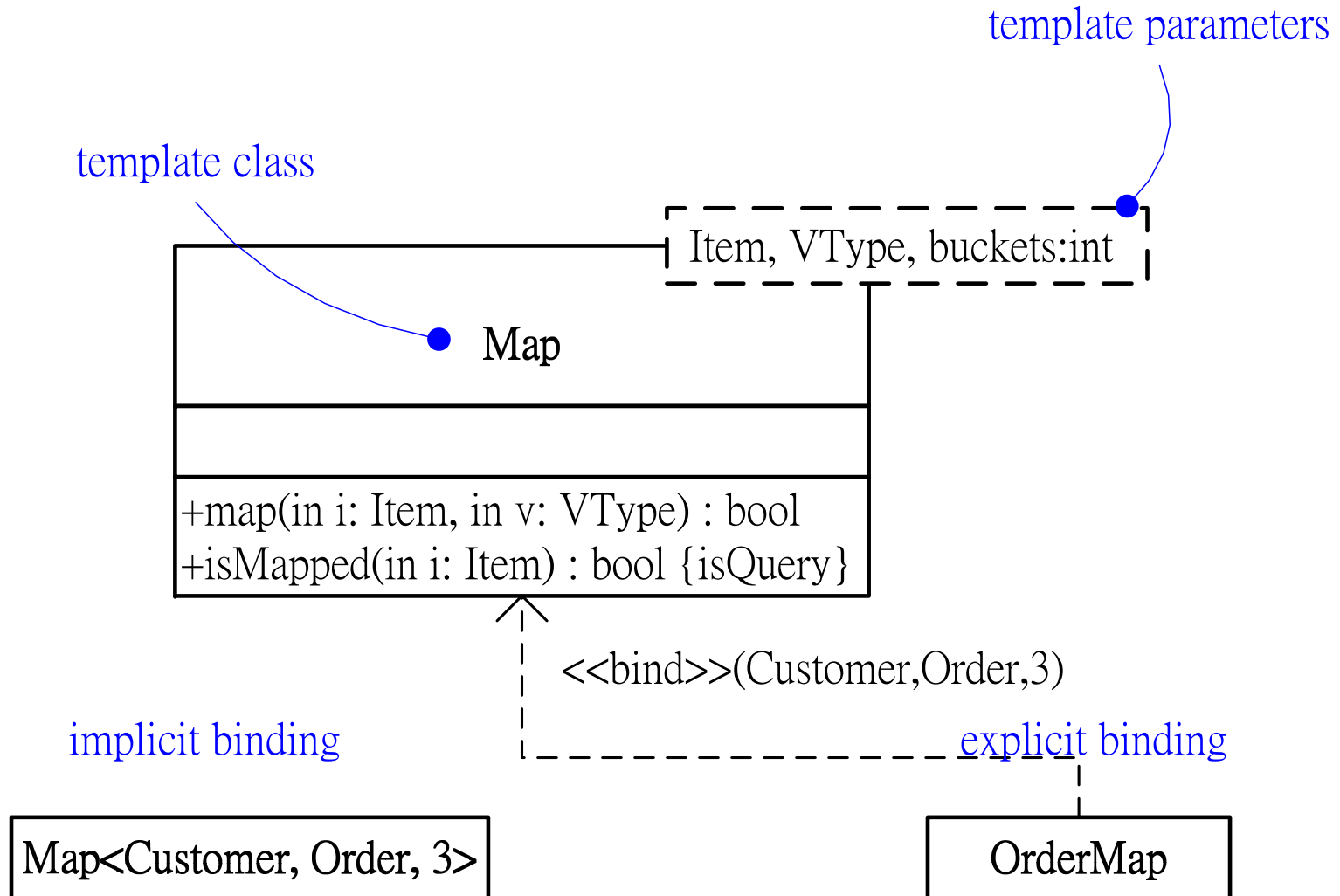

Advanced Relationships

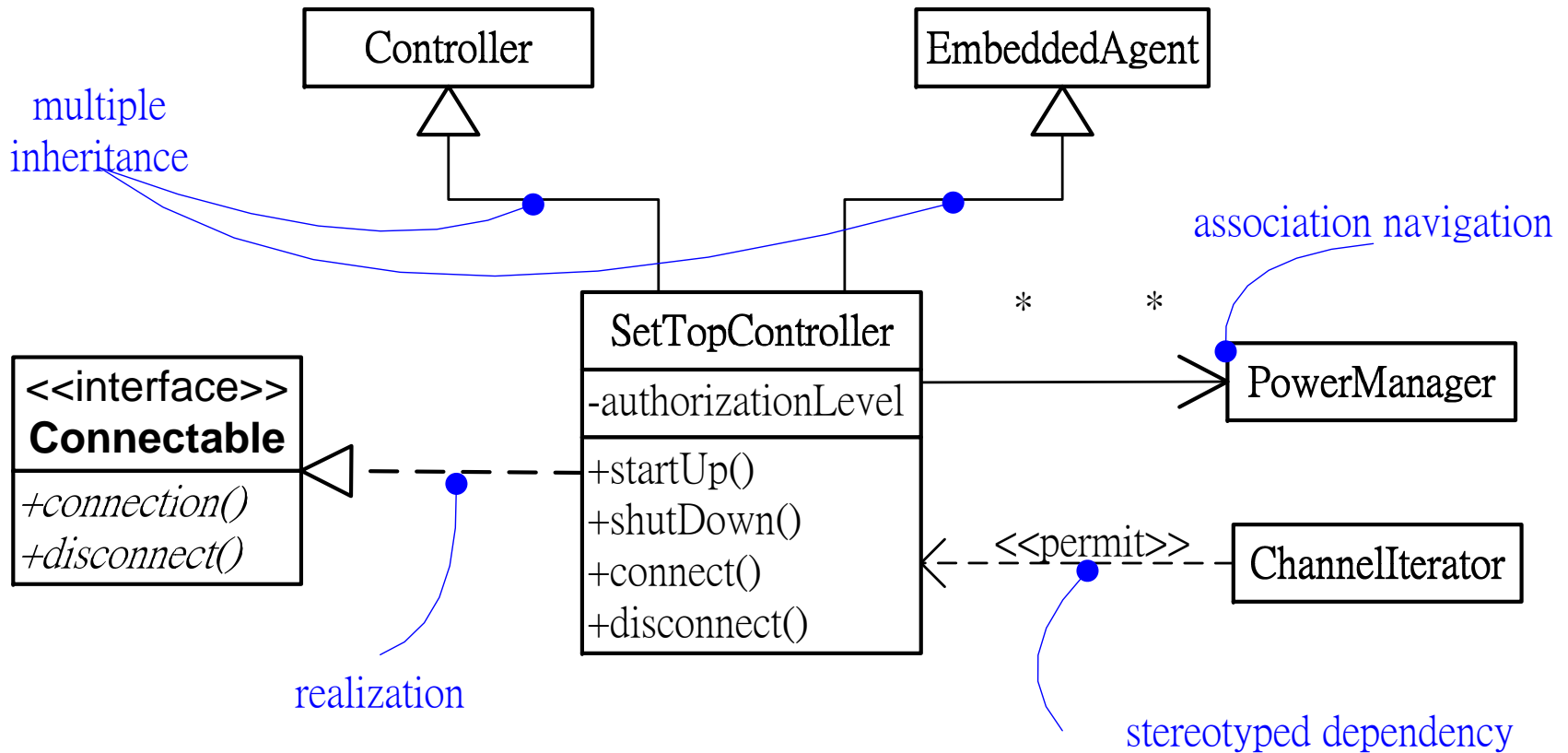

Advanced Relationships (cont.)

- Stereotypes for dependency
 - Among classes and objects (in class diagrams): **bind, derive, permit (friend), instanceof, instantiate, powertype, refine, use**
 - Among packages: **import, access**
 - Among use cases: **extend, include**
 - In state machines: **send**
 - In subsystems and models: **trace**

Advanced Relationships (cont.)

- A stereotype for generalization:
 - **implementation**
- Constraints for generalization:
 - **complete, incomplete, disjoint, overlapping**

Advanced Relationships (cont.)

- Properties of association
 - Navigation
 - Visibility
 - Qualification
 - Interface specifier
 - Composition
 - Association classes
 - Constraints: **ordered, set, bag, ordered set, list or sequence, readonly**

Realizations

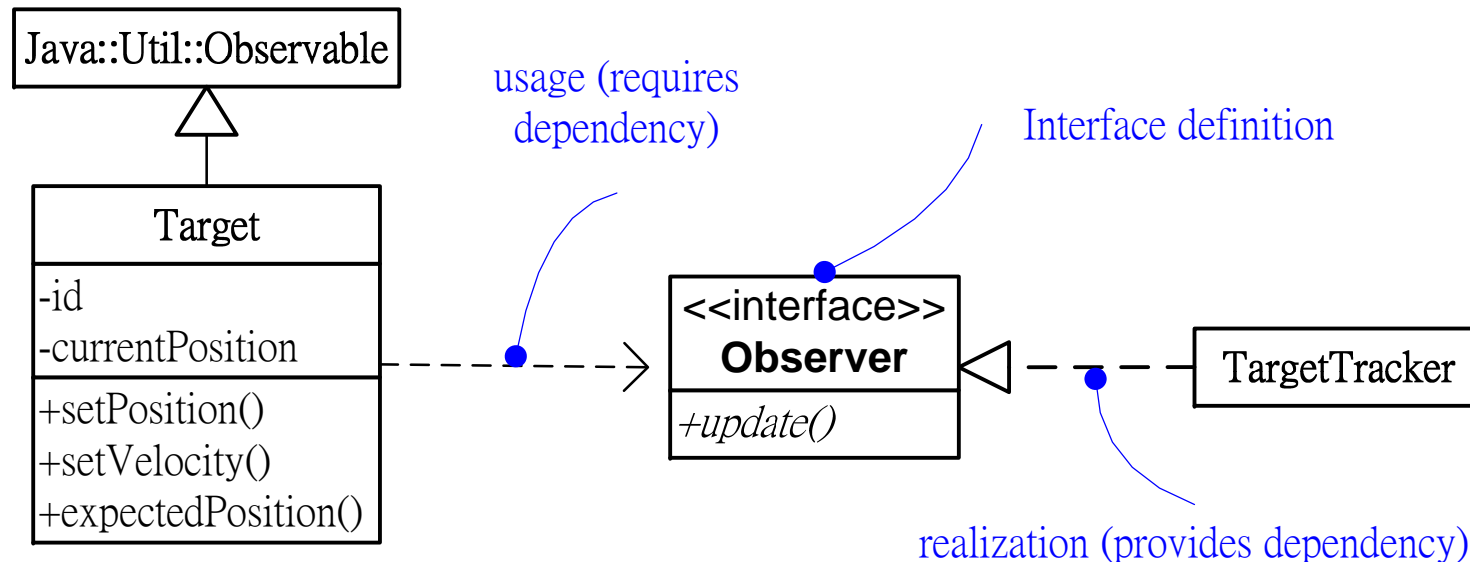
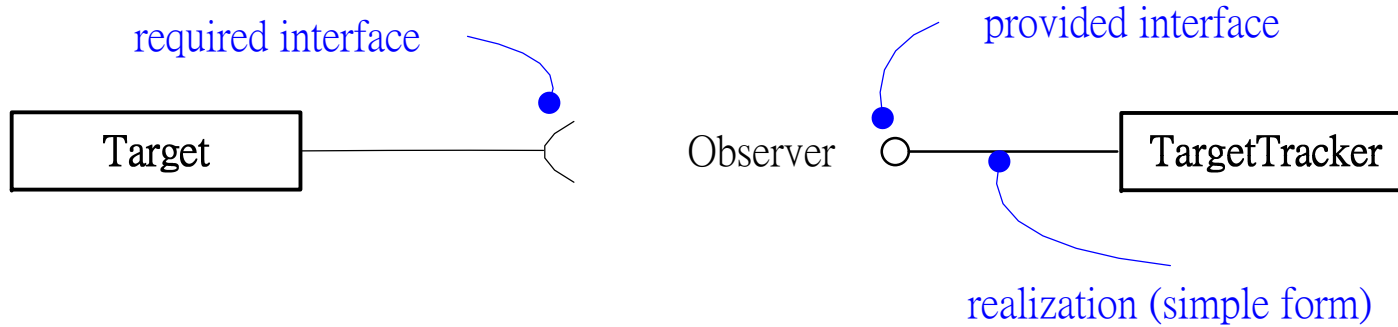

Sequence Diagram

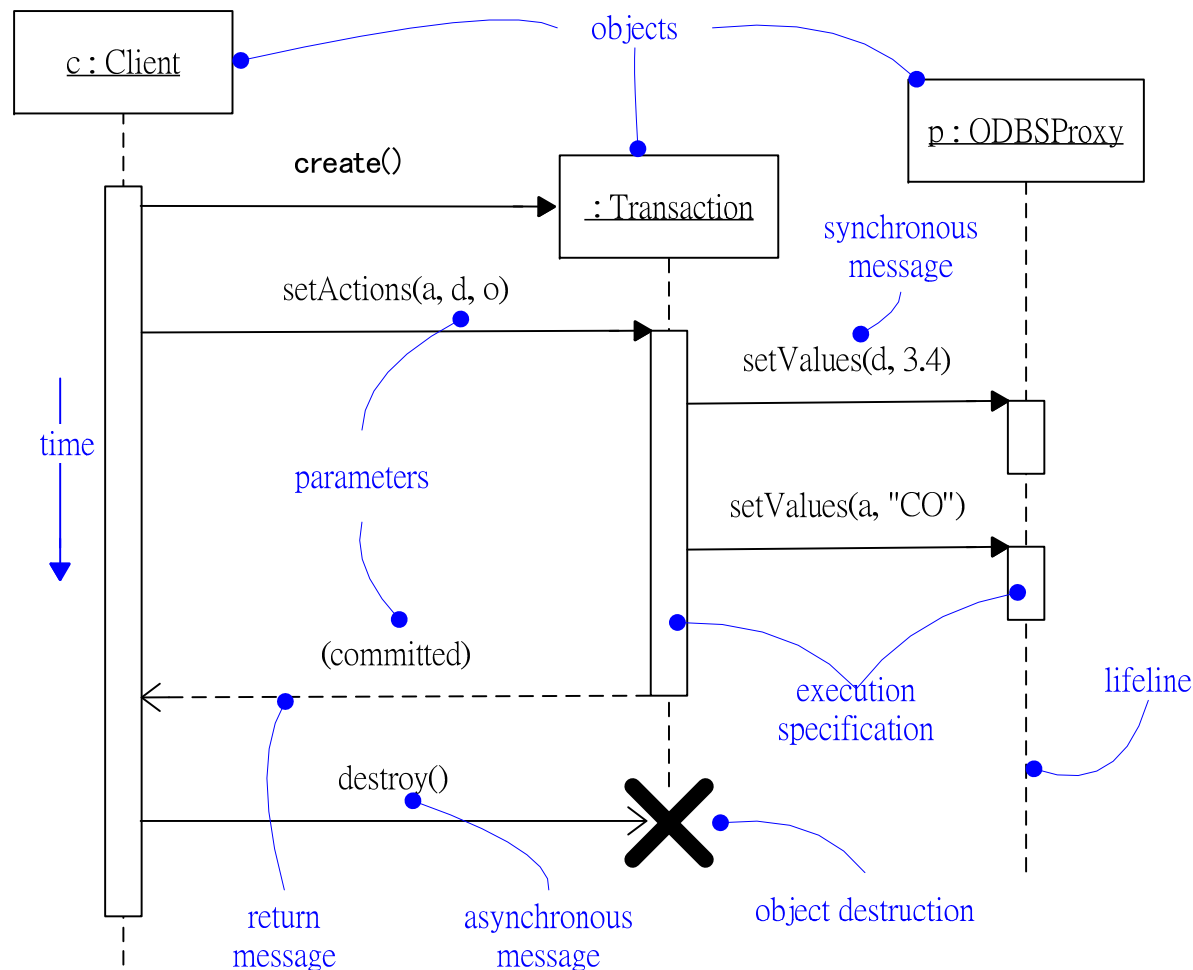

Communication Diagram

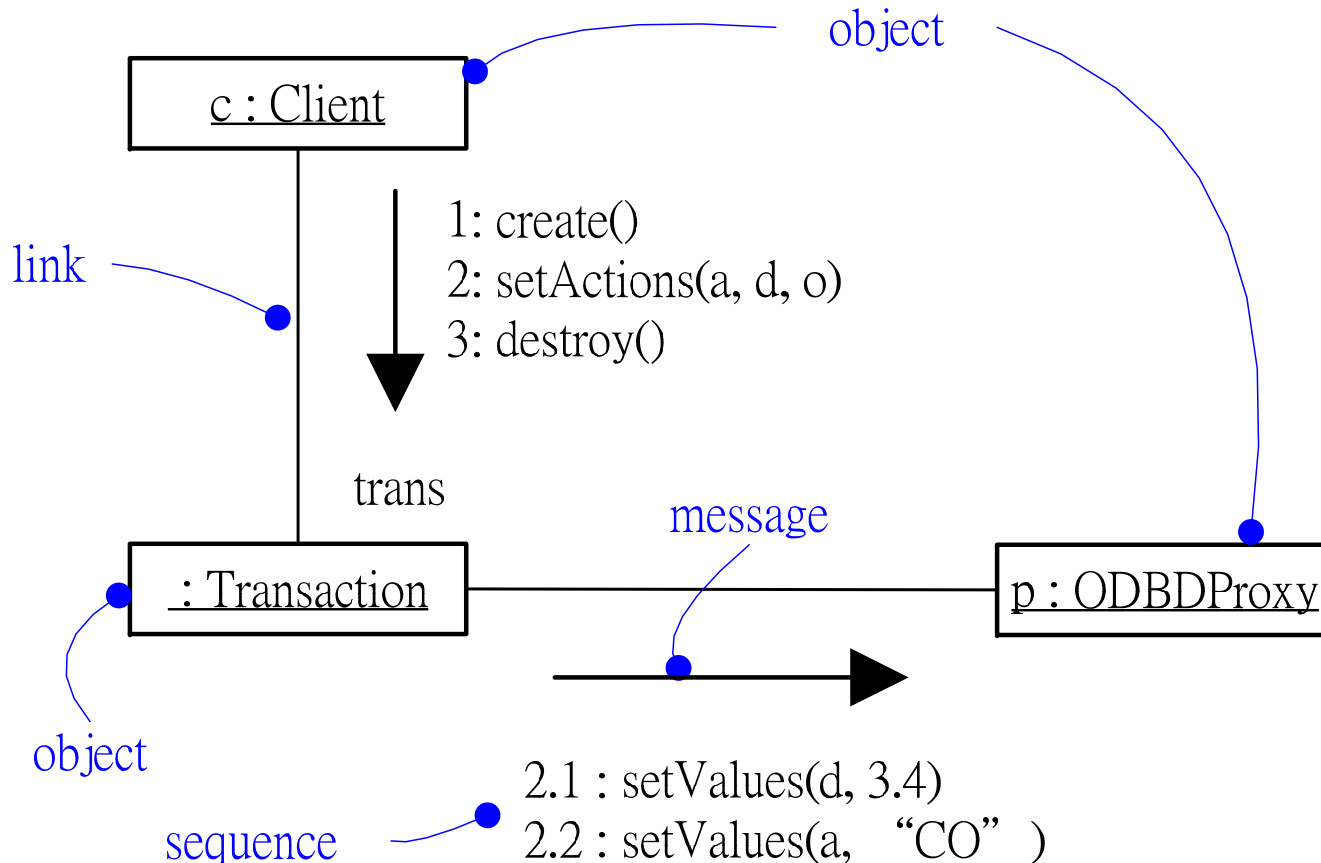

Use Case Diagram

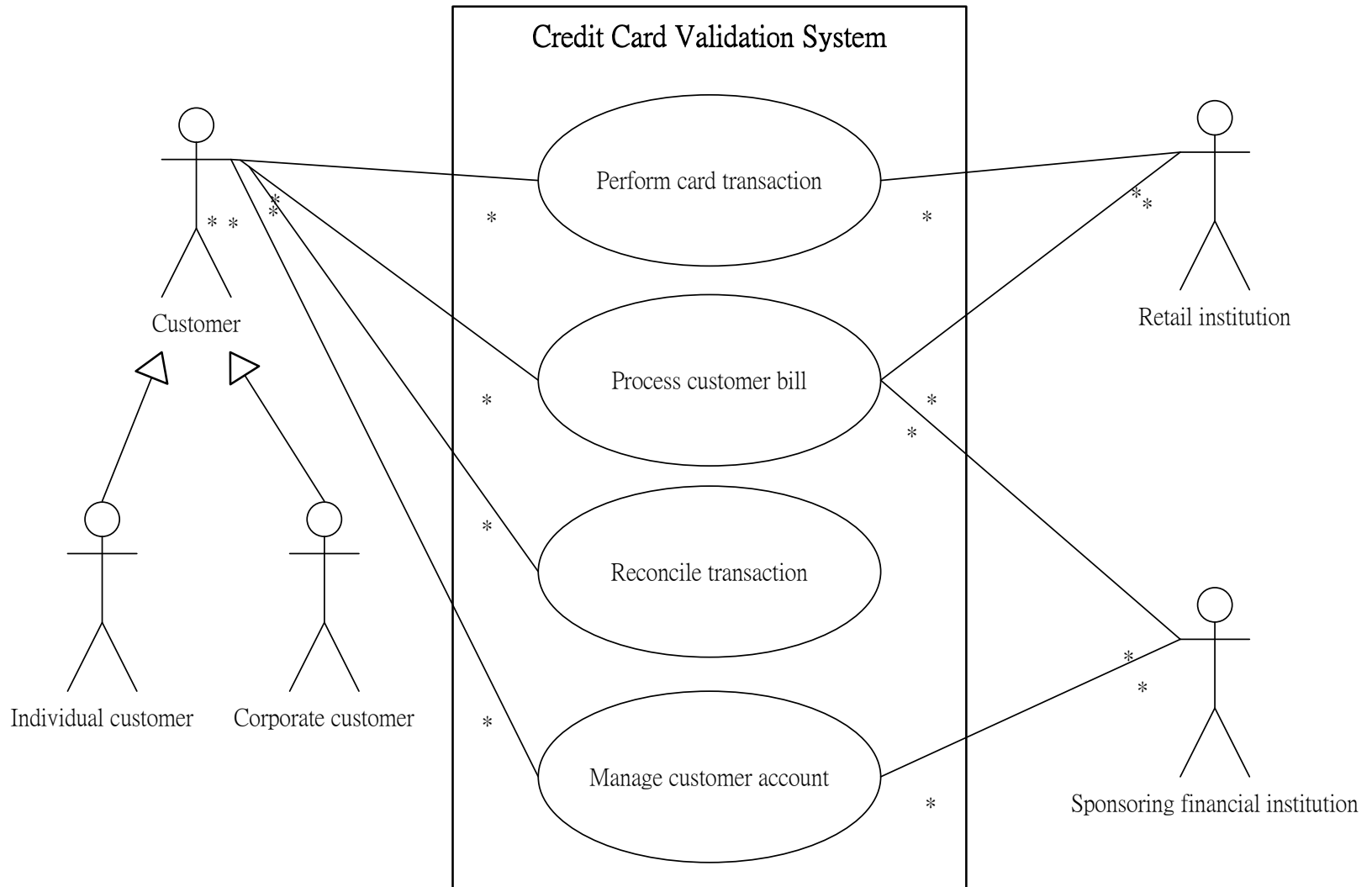

Activity Diagram

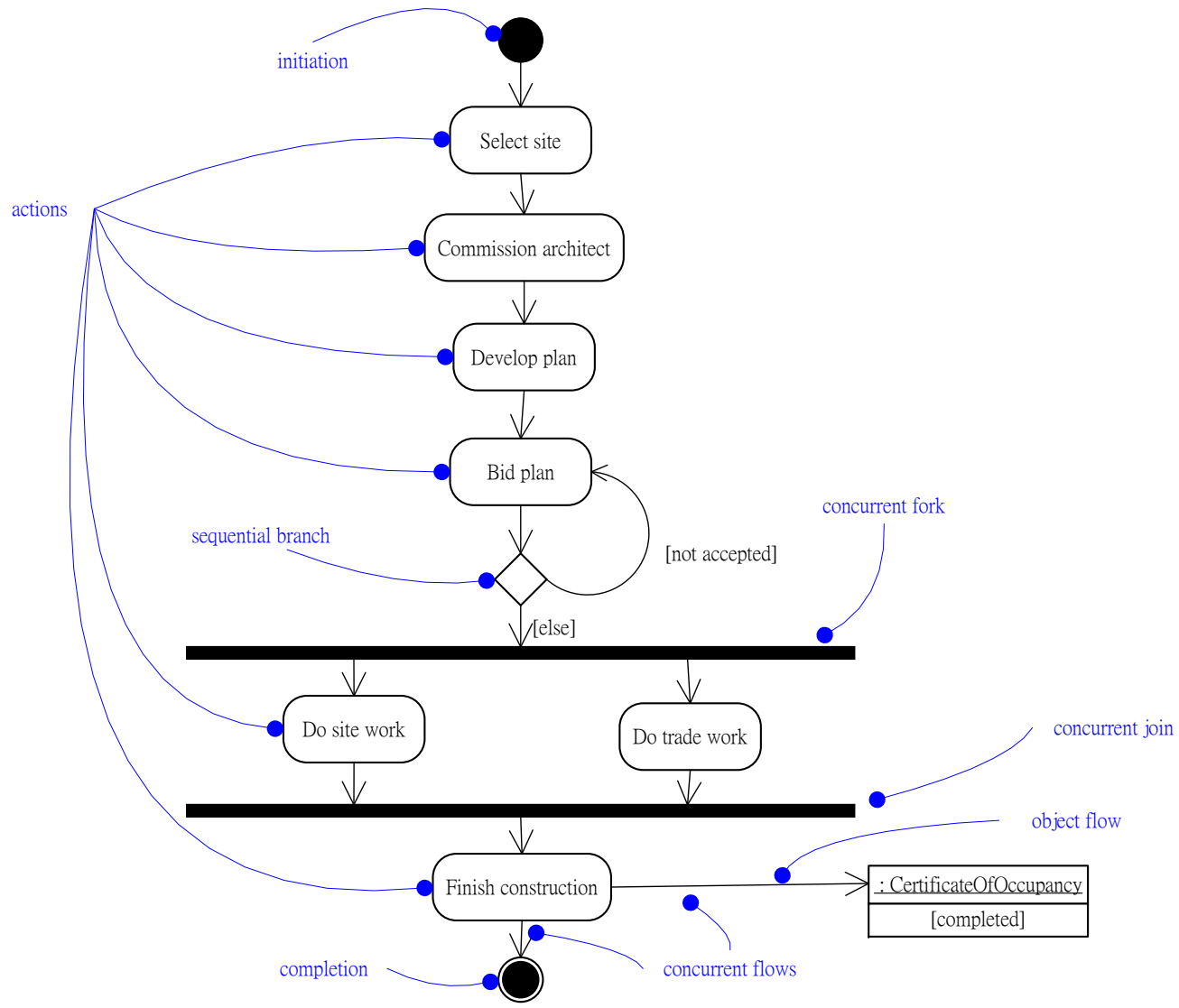

Swimlanes and Object Flow

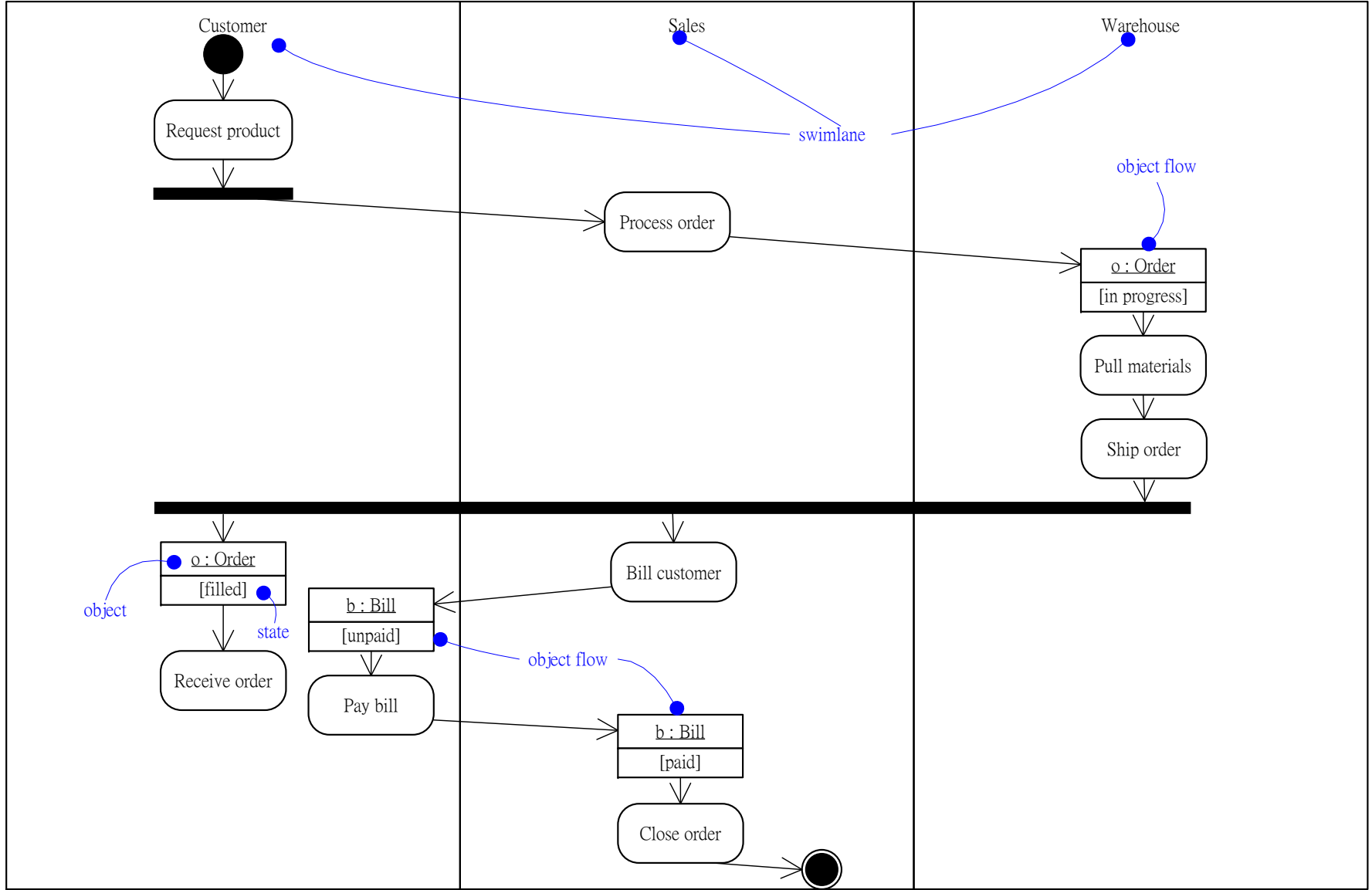

Instances

- An **instance** is a concrete manifestation of an abstraction
 - **Set of operations** (that can be applied to the instance)
 - **State** (that stores the effects of operations)
- **Graphical notation:**

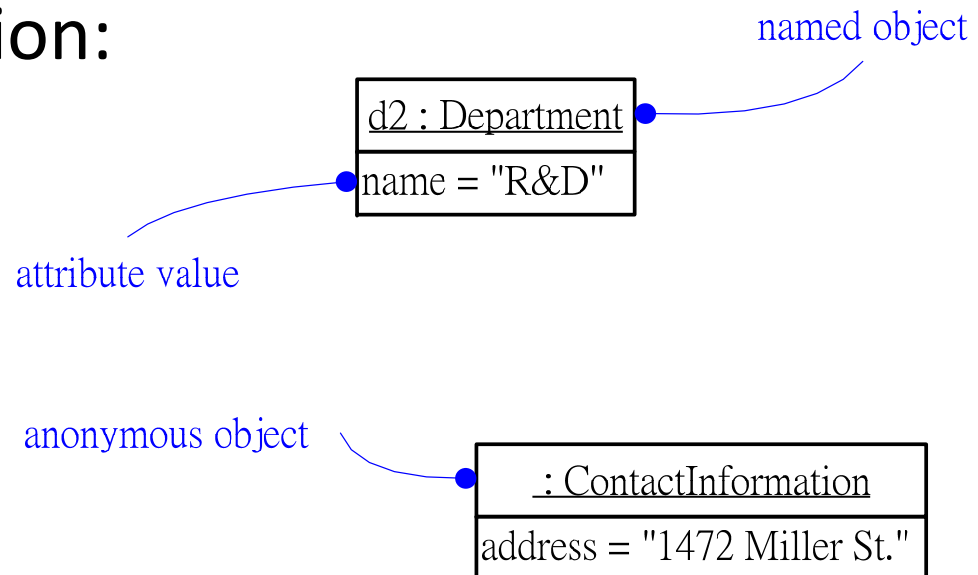

Object Diagrams

- An object diagram shows a set of objects and their relationships at a point in time.

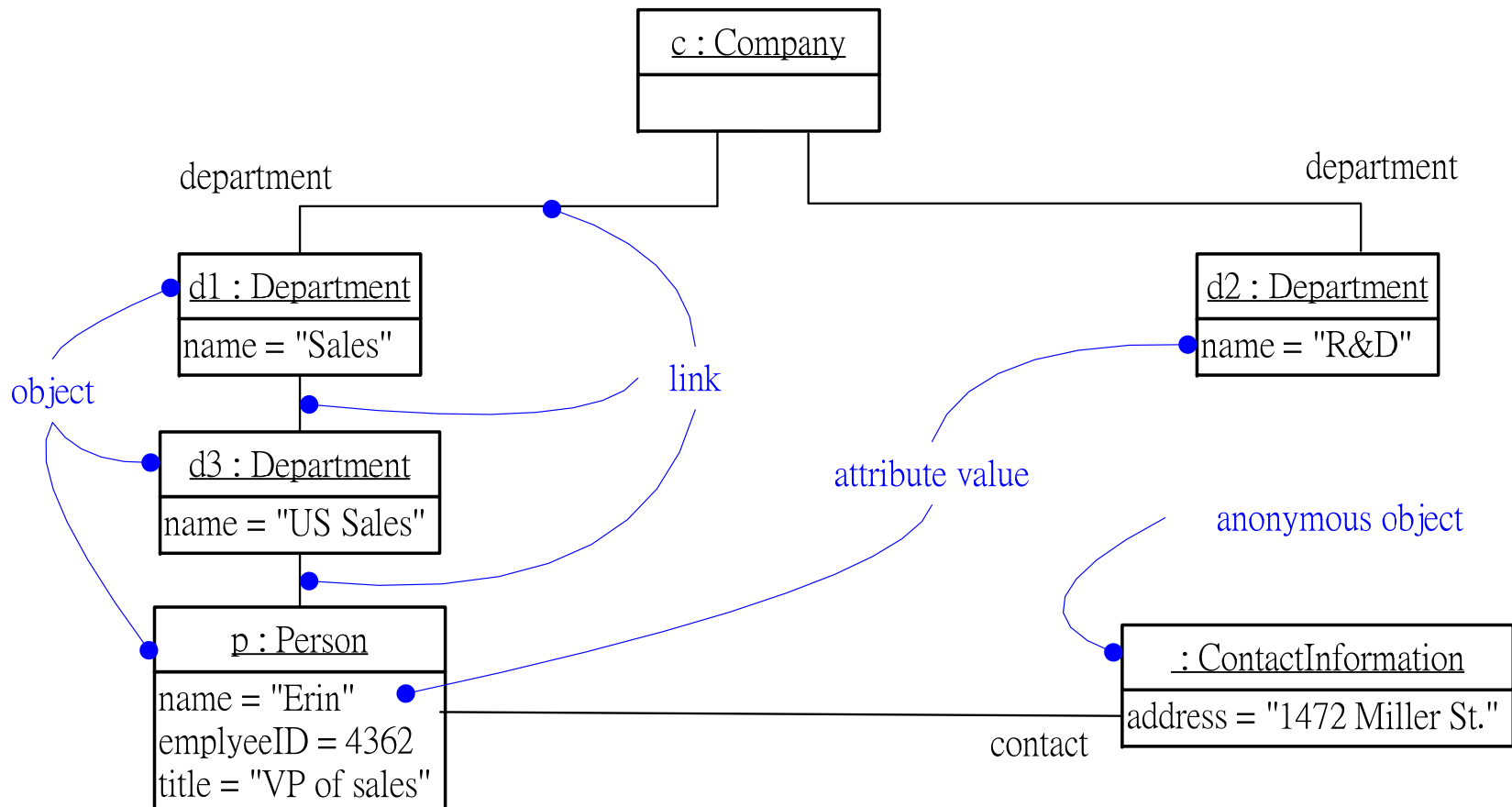

Modeling Object Structures

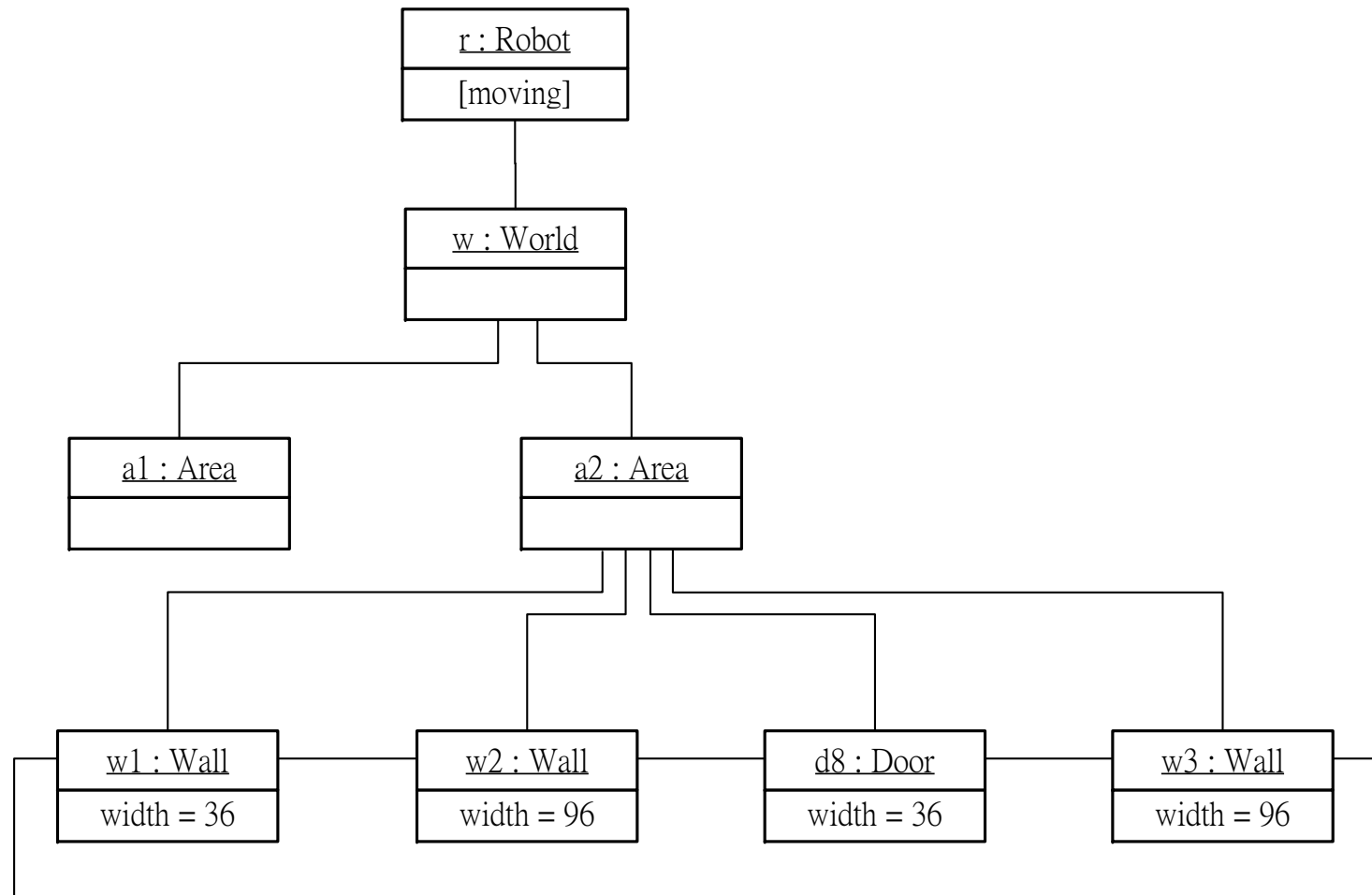

Components

- A **component** is a *logical, replaceable* part of a system that conforms to and realizes a set of *interfaces*.
- Relevant concepts
 - **Interface**: a collection of operations. Interfaces are the glue that binds components together.
 - **Port**: a window for accepting and sending messages
 - **Internal structure**: implementation of a component
 - **Part**: a unit of the implementation
 - **Connector**: a communication relationship between two parts or ports

Component Diagrams

- Components are bound by interfaces.

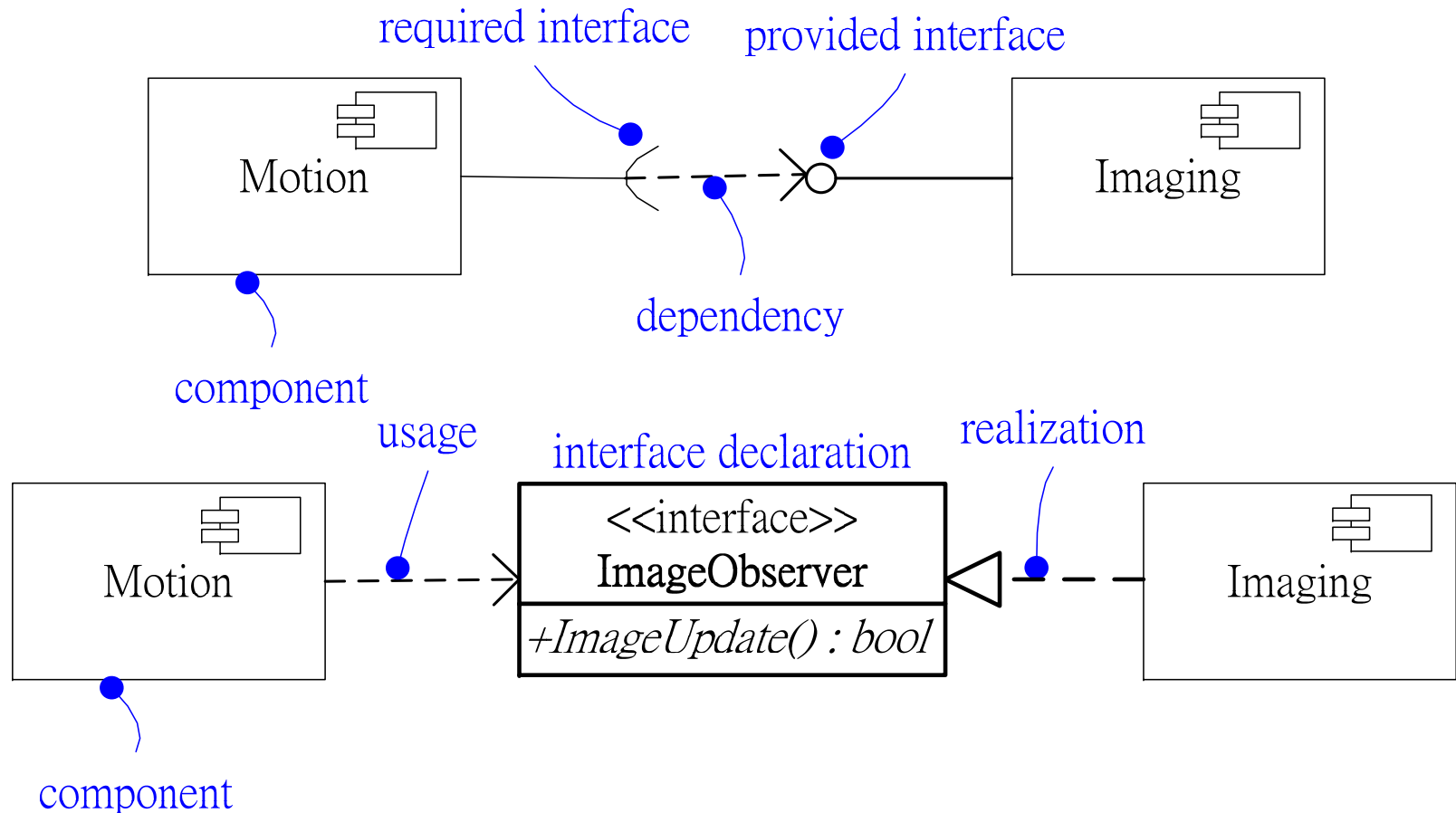

Component Diagrams (cont.)

- Components can be nested.

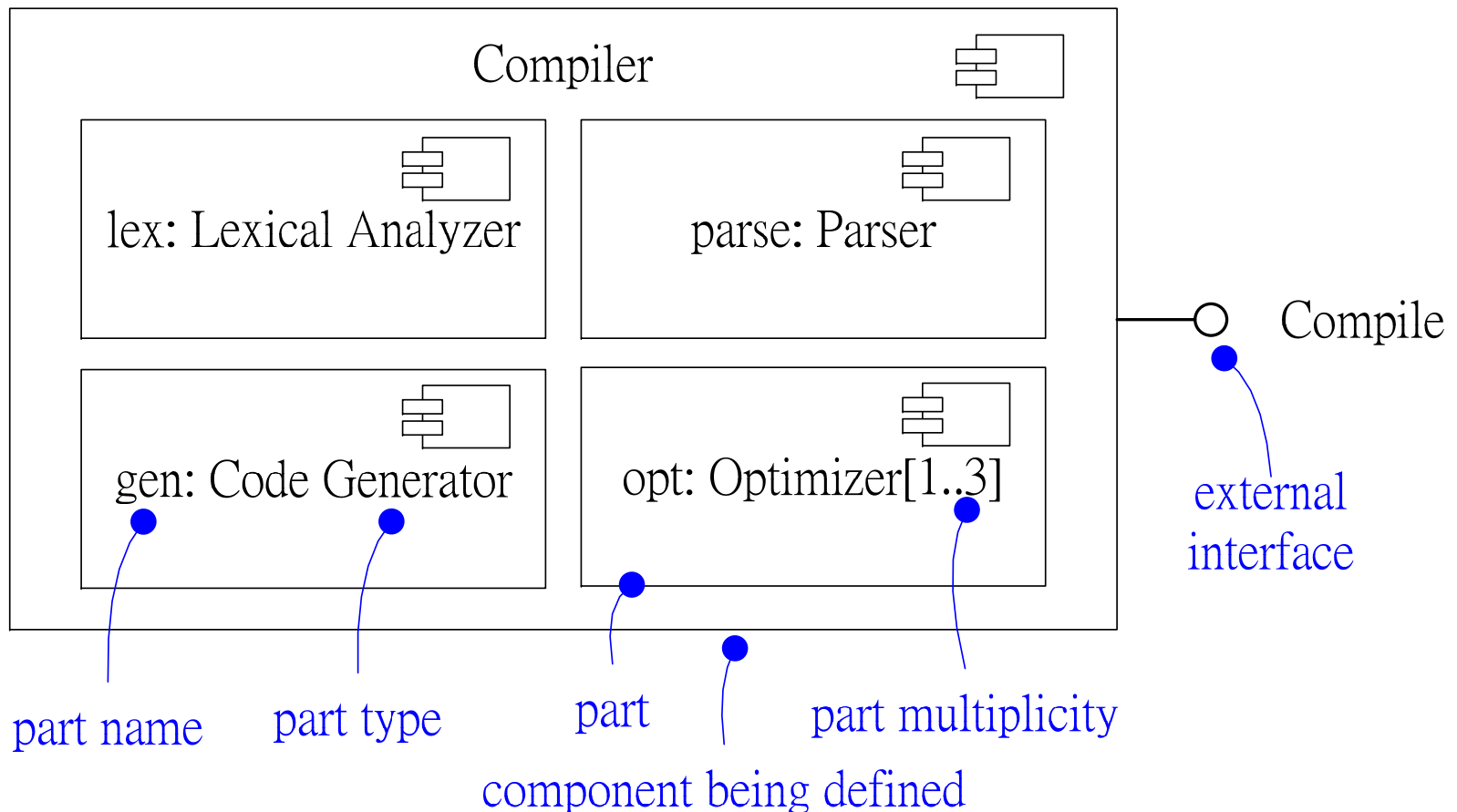

Events and Signals

- “Things that happen” are called **events**.
- They are used to model the occurrence of a stimulus that changes the state of a system.
- Events may include
 - Signals,
 - Calls,
 - The passing of time, or
 - A change in state
- Events may be synchronous or asynchronous.

State Machines

- A state machine models the lifetime of an object.

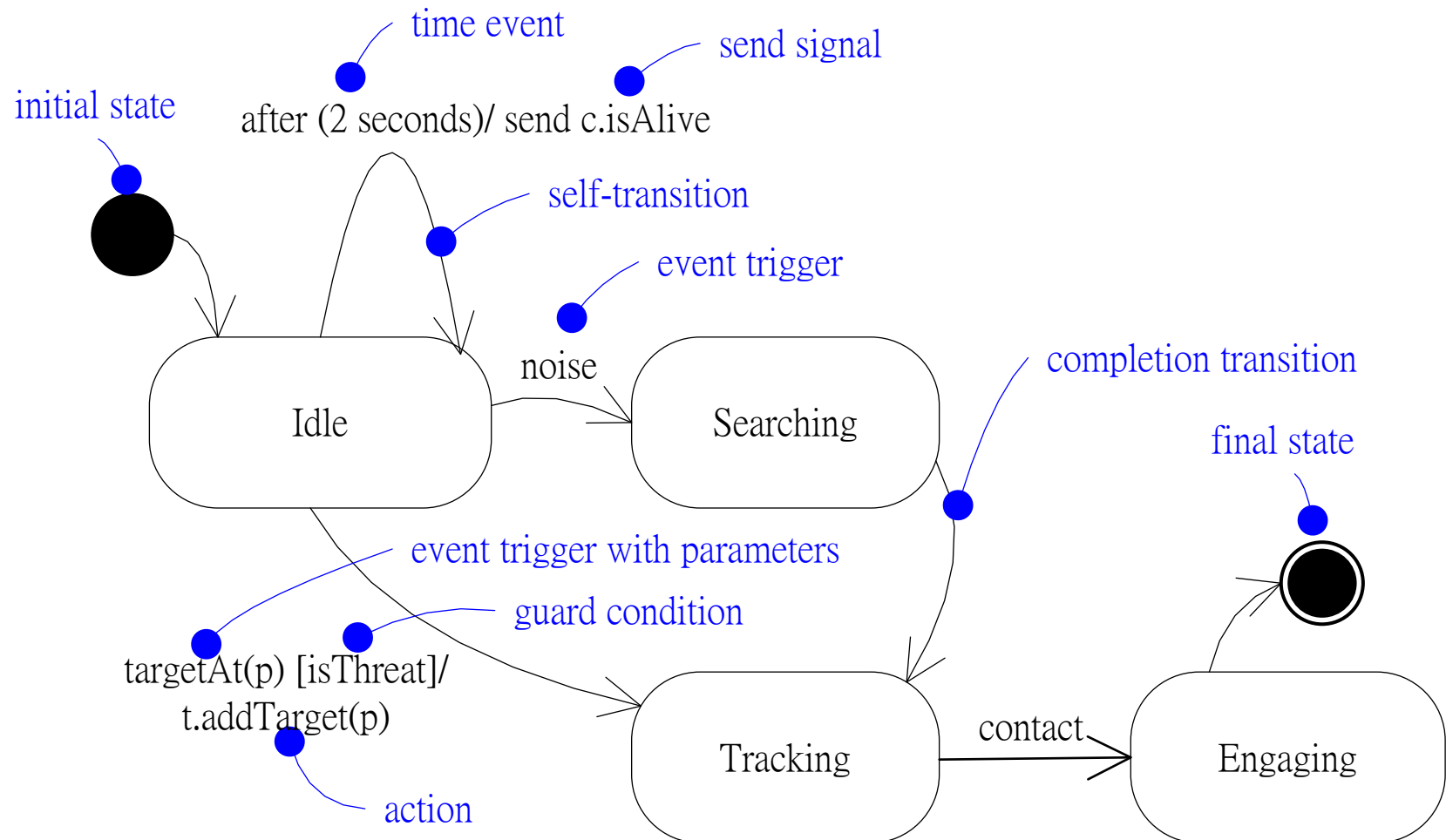

Advanced States and Transitions

- Entry/exit effects
- Internal transitions
- Do-activities
- Deferred events
- Submachines
- Nonorthogonal vs. orthogonal states
(sequential vs. concurrent states)
- History states (cf. static variables in C)
- Fork and Join

State (State-machine) Diagrams

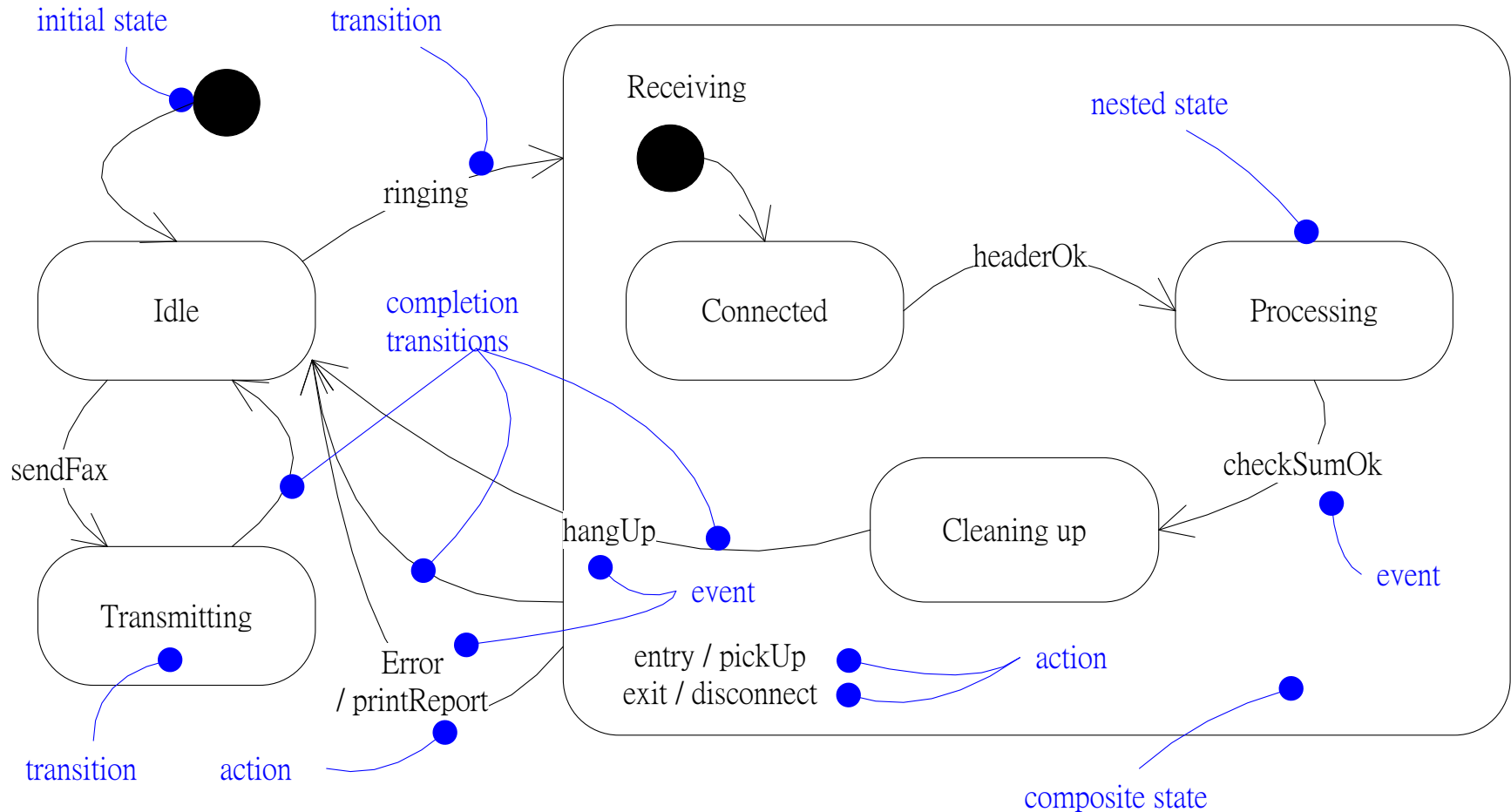

Processes and Threads

- Flow of control
 - Heavyweight: **Process**
 - Lightweight: **Thread**
- Active class/object (representing a process or thread)
- Communication
- Synchronization
 - Sequential
 - Guarded
 - Concurrent

Communication

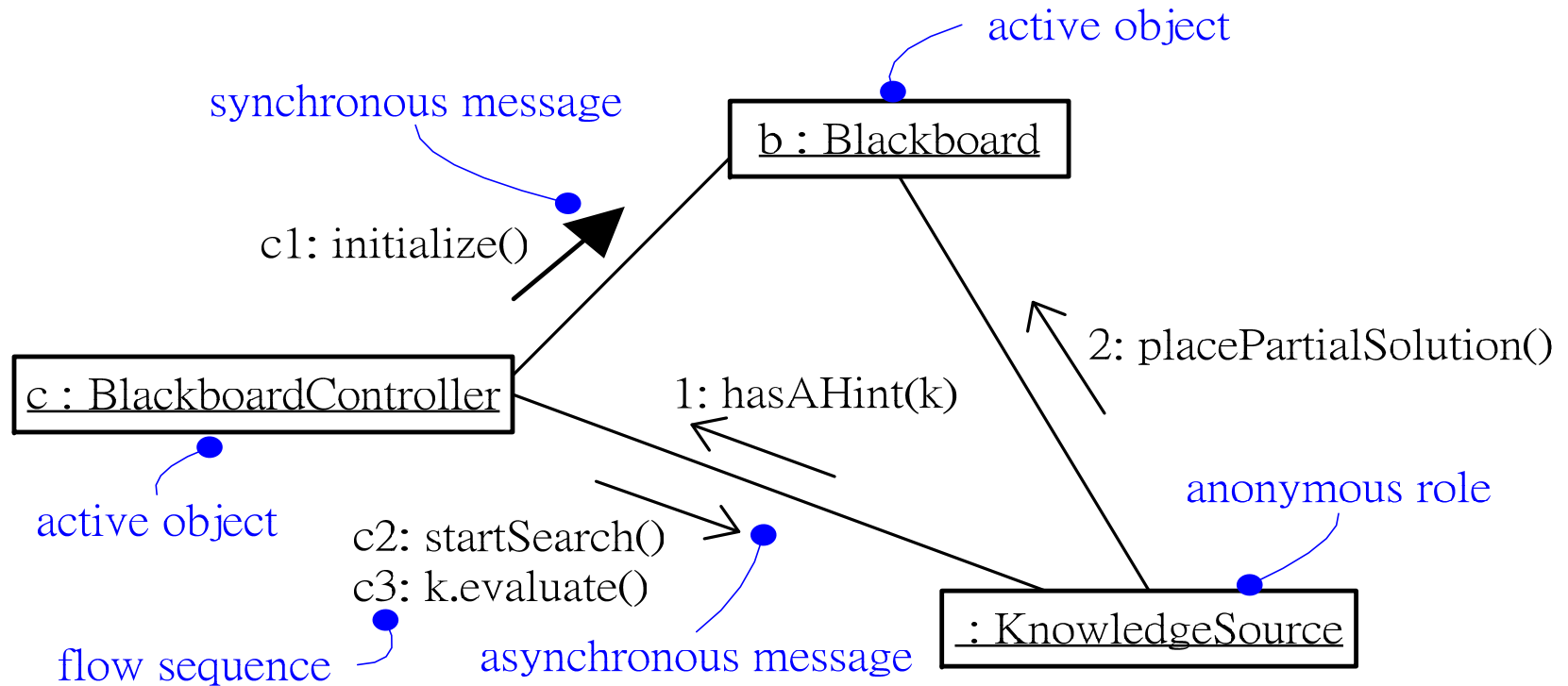

Timing Constraints

- Some systems may be time-critical.
- Even if not time-critical, meeting more stringent timing constraints is a good indicator of efficiency.
- Typical timing constraints:
 - Duration
 - Frequency

Duration Constraints

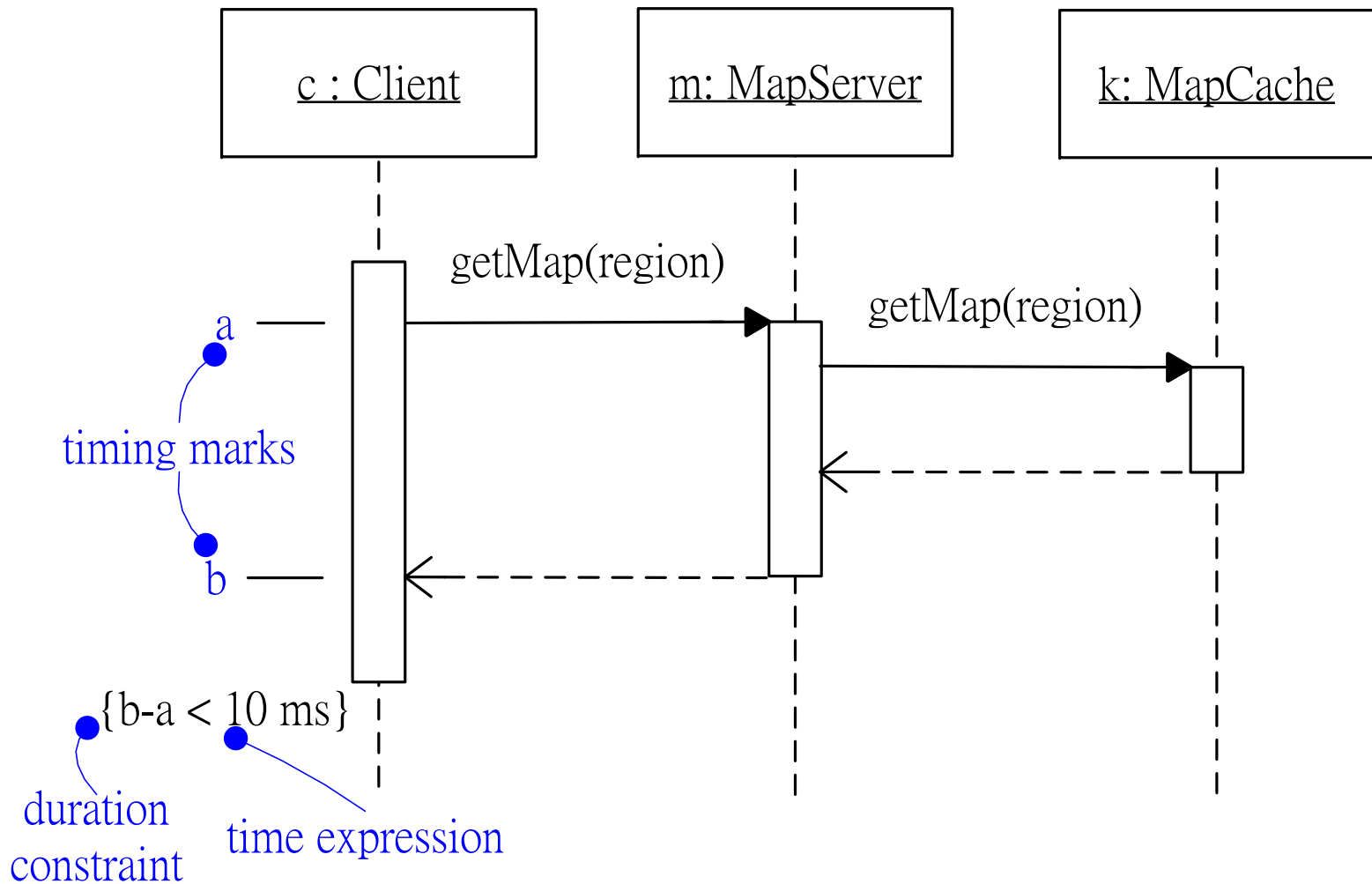

Improvements Made in UML 2.0

- Hierarchical decomposition of structures and support for component-based development:
 - Composite structure diagrams
- Hierarchical decomposition of behavior
- Improved integration between structural and behavioral models
- Support for executable models
 - fully integrated Action Semantics