

UML: An Overview

(Based on [Booch *et al.* 2005])

Yih-Kuen Tsay

Dept. of Information Management

National Taiwan University

Outline

- Introduction
- Basics of Modeling
- Overview of the UML
- Sample UML Diagrams

Introduction: History of the UML

- The UML---**Unified Modeling Language**, is a standard graphical language for “drawing a system’s blueprints”
- It was initially the result of an effort in unifying the Booch, OOSE, and OMT methods
- Most major software companies eventually got involved, resulting in UML 1.1 (1997)
- Its maintenance was then taken over by OMG
- Adoption of a major revision---**UML 2.0** was completed in 2005
- The current stable version is UML 2.3 (May 2010)

Intro.: What the UML Is For

- For “drawing a system’s blueprints”
- More specifically, for
 - Visualizing
 - Specifying
 - Constructing
 - Documenting

object-oriented, software-intensive systems.

(This corresponds to the four aims of modeling.)

Intro.: Whom the UML Is For

- **Analysts and End Users:** specify the (structural and behavioral) requirements
 - **Architects:** design systems that meet the requirements
 - **Developers:** turn the design into executable code
 - **Others:** quality assurance personnel (e.g., testers), technical writers, librarians, project managers, ...
- All roles in software development should know something about the UML.

Importance of Modeling

- Mind the **scale**:
 - dog house
 - family house
 - office building
- The use of modeling is a **common thread** of successful software projects
- In fact, modeling can be found in **every discipline/profession**

Basics of Modeling

- What is a model?
 - simplification of reality
 - blueprints of a system: structural or behavioral
- Why do we model?
 - To better understand the system under development
 - To focus on one aspect at a time (it is not possible to comprehend a complex system in its entirety, so divide and conquer ...)

Four Aims of Modeling

- To **visualize** a system
- To **specify** its structure and/or behavior
- To provide a **guiding template** for **construction**
- To **document** the decisions made

More Tips

- Use a **common** language
- Do modeling now, before it is too late
 - Things may get more complex than expected

Principles of Modeling

- Models influence the solutions (so, choose your models well)
- Different levels of precision may be expressed
- Good models are connected to reality
- No single model is sufficient; multiple models/views are needed

Five Views of an Architecture

The four aims of modeling demand the system be viewed from different perspectives:

- **Use case view**: exposing the requirements
- **Design view**: capturing the vocabulary of the problem/solution space
- **Process view**: processes and threads
- **Implementation view**: physical realization
- **Deployment view**: system engineering issues

Object-Oriented Modeling

- The main building blocks of all software systems are **objects** and **classes**
- An object is a thing drawn from the vocabulary of the problem/solution space
- Every object has an identity, a number of **states**, and **behavior**
- A class defines a set of common objects

Overview of the UML

- Things
- Relationships
- Diagrams

The UML in the Software Development Process

- The UML allows one to express **different views** of a system and their interactions
- The UML is largely **process-independent**
- The OMG recommends using the UML with the so-called *Unified Software Development Process*:
 - Characteristics: (1) **use case driven**; (2) **architecture-centric**; (3) **iterative and incremental**
 - Four phases of an iteration: **inception**, **elaboration**, **construction**, **transition**

Things in the UML

■ Structural Things

- Class, interface, collaboration, use case, active class, component, artifact, node

■ Behavioral Things

- Interaction (messages, action sequences, links)
- State machine (states, transitions, events)

■ Grouping Things: packages

■ Annotational Things

Structural Things (I)

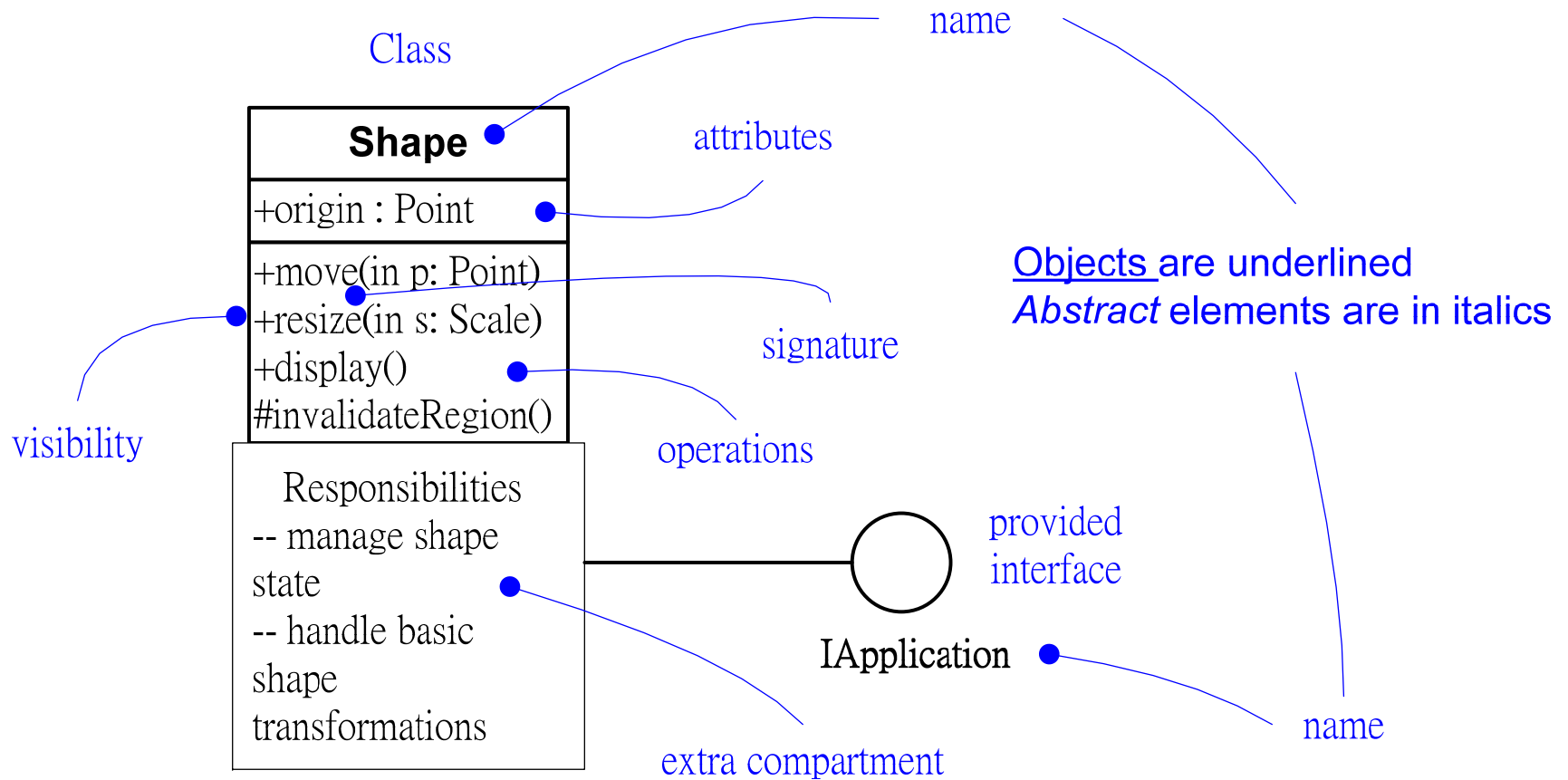

Structural Things (II)

Collaboration

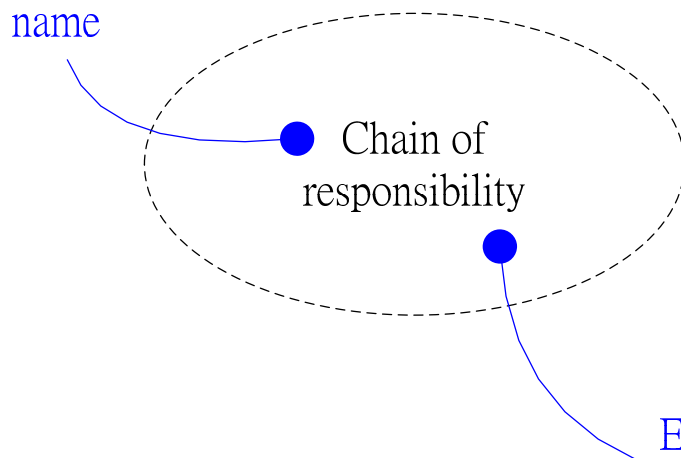

Use Case

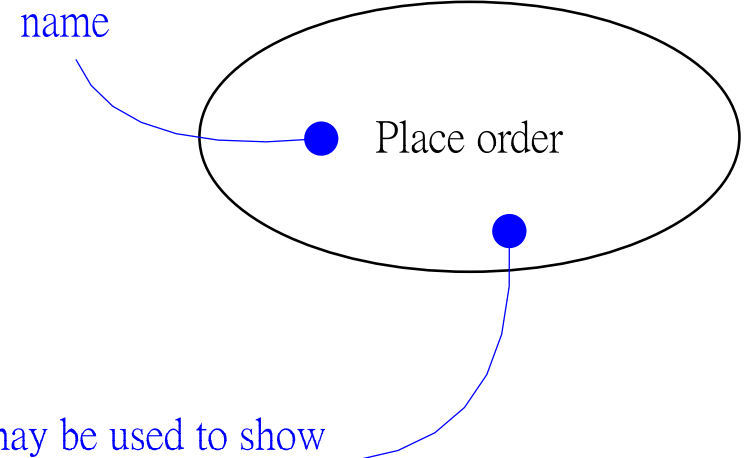

Extra compartments may be used to show contents.

Structural Things (III)

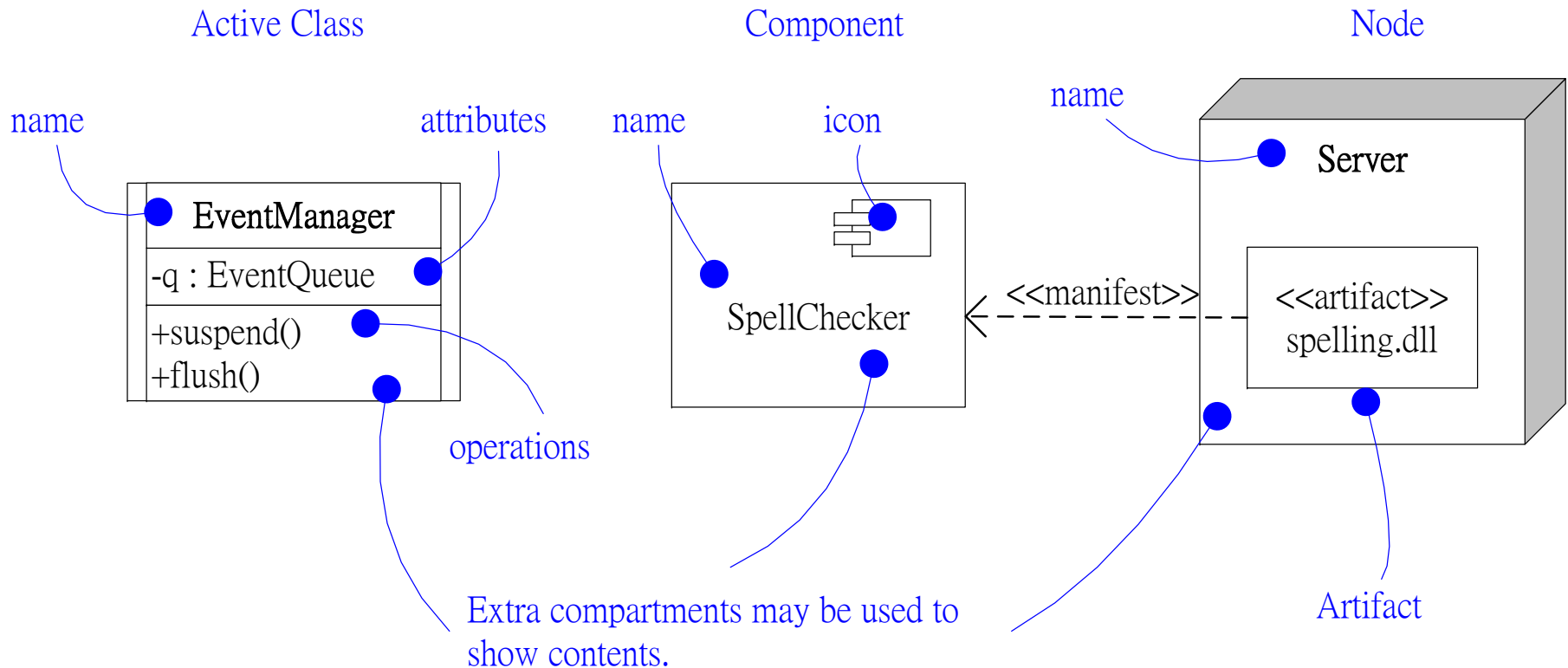

Behavioral Things (I)

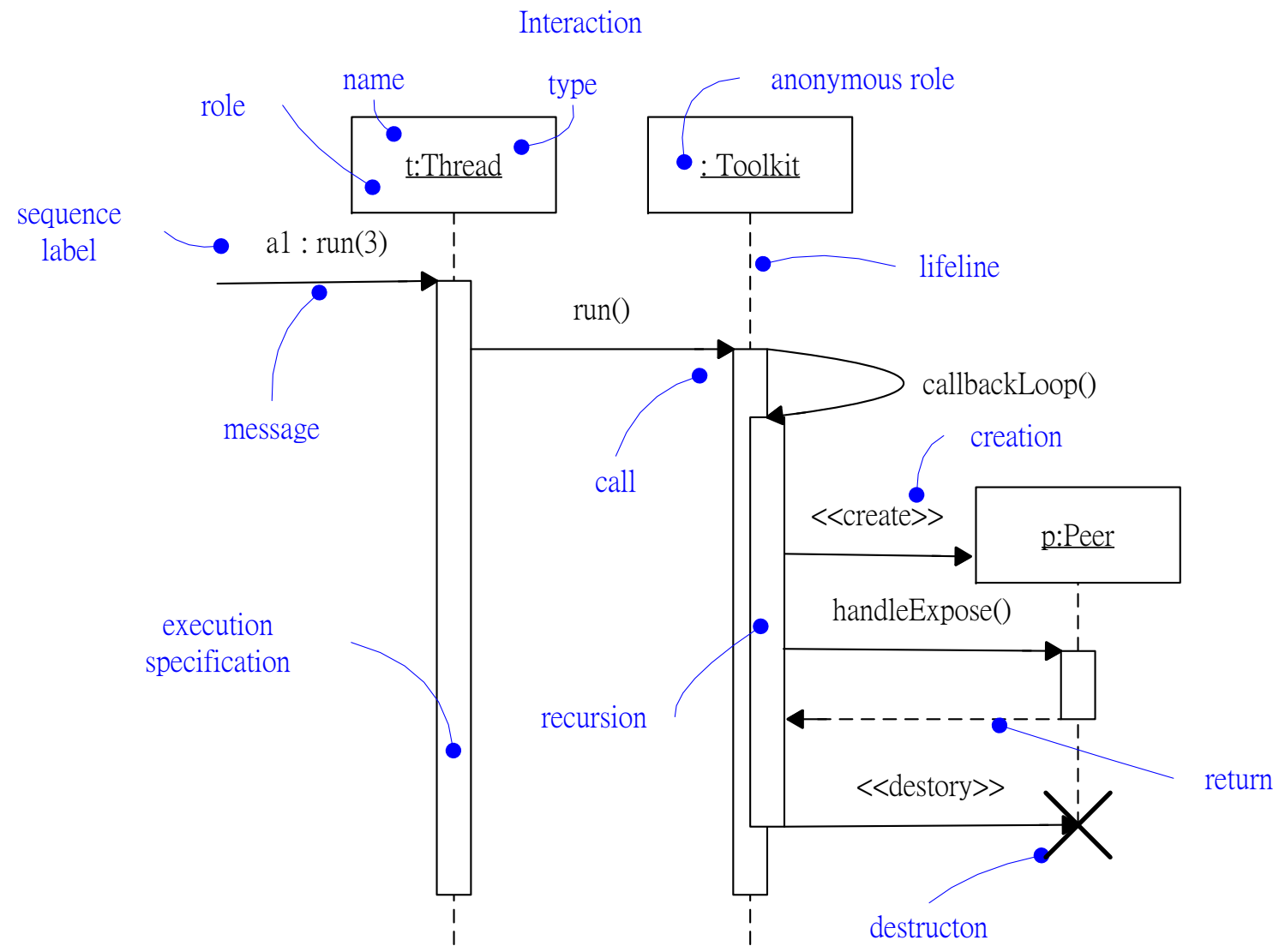

Behavioral Things (II)

State Machine

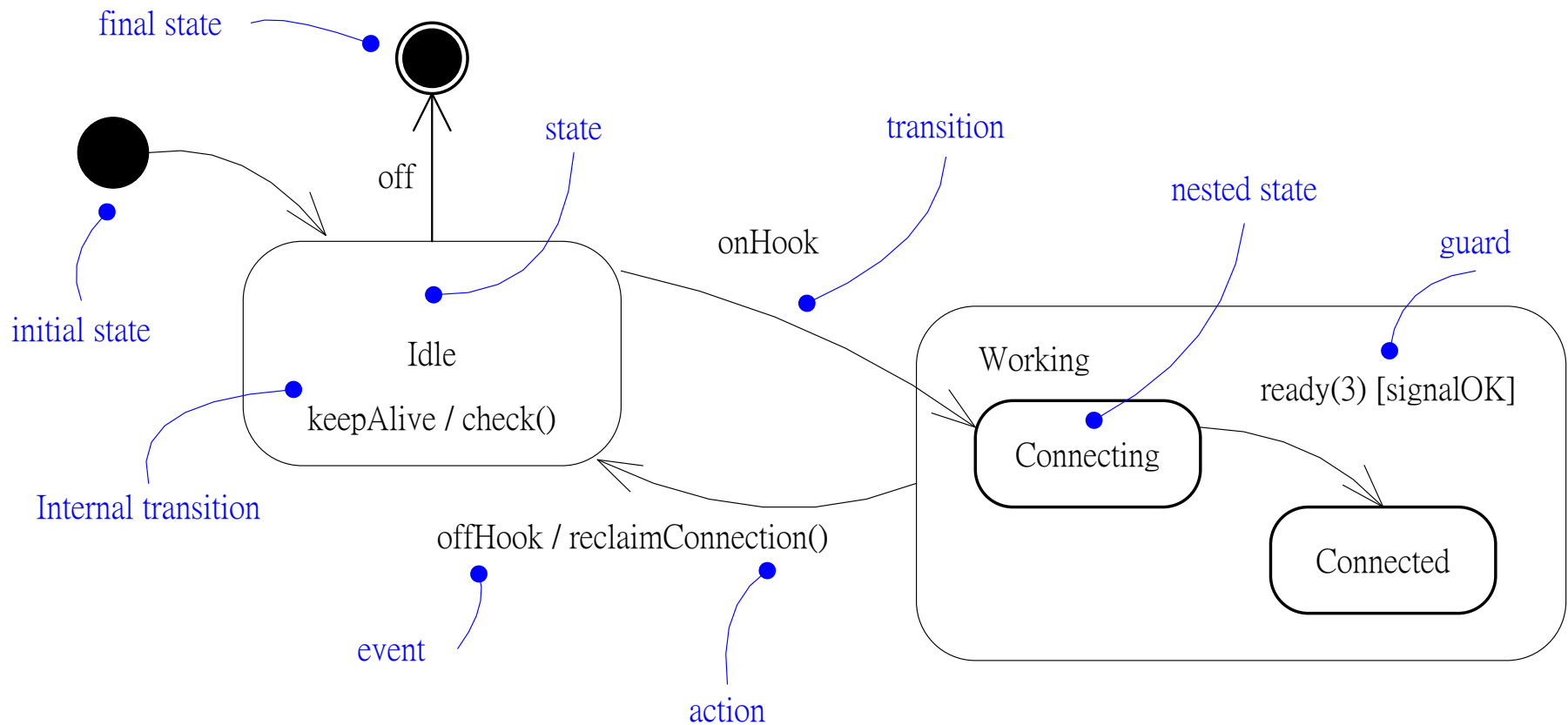

Grouping Things

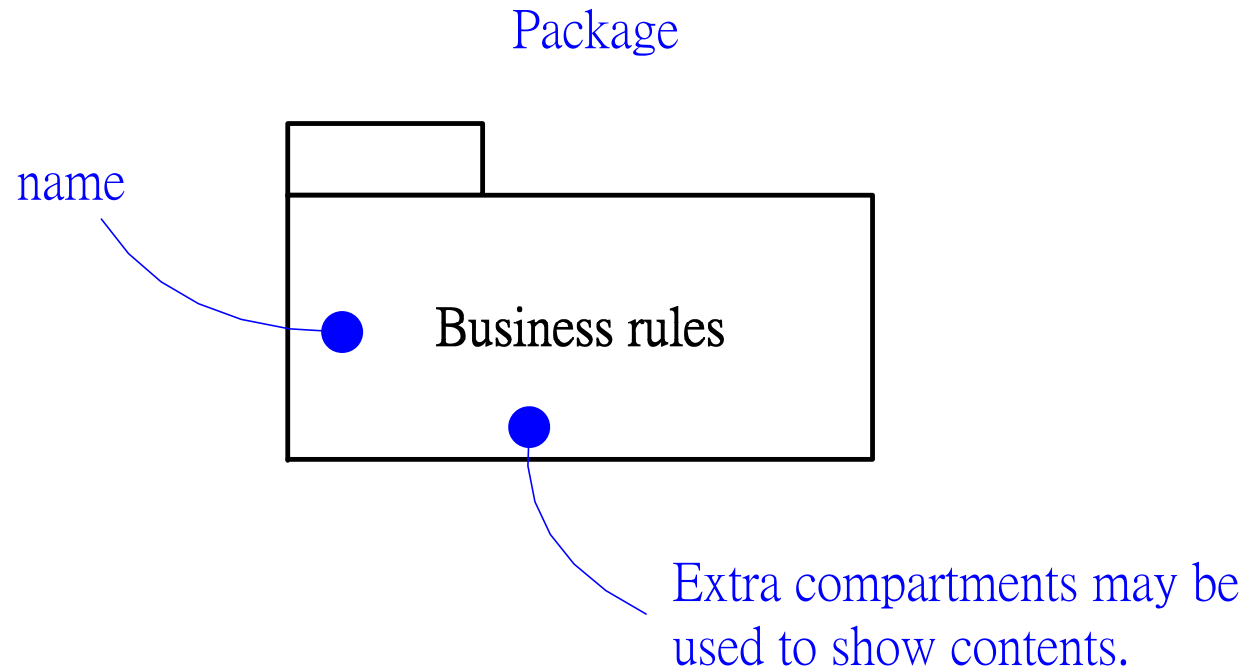

Annotational Things

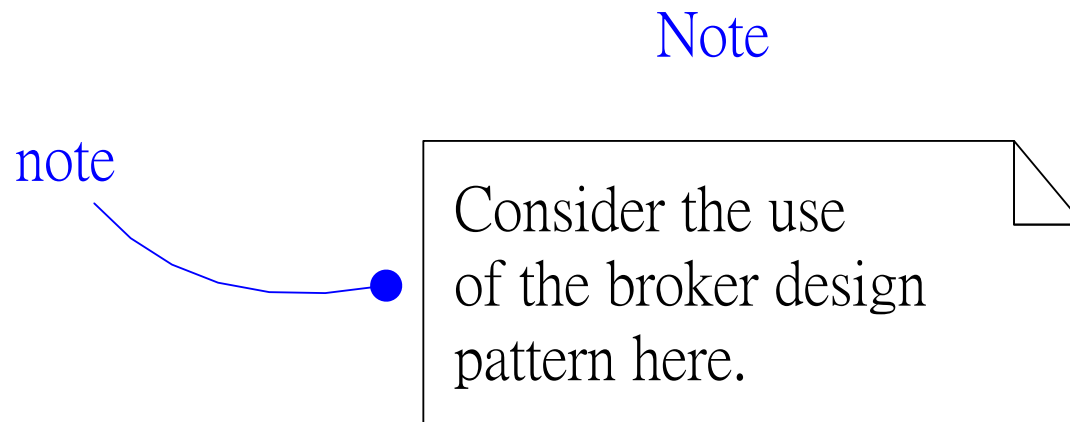

Relationships in the UML

- Dependency
- Association
- Generalization
- Realization

Relationships

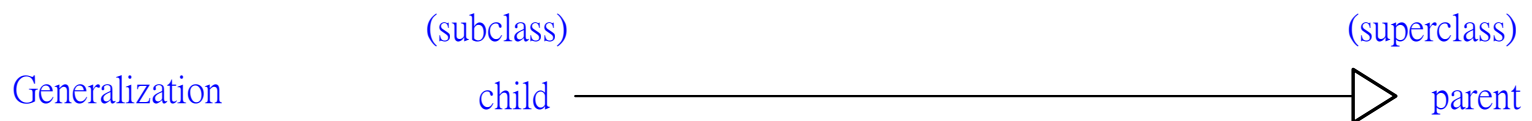
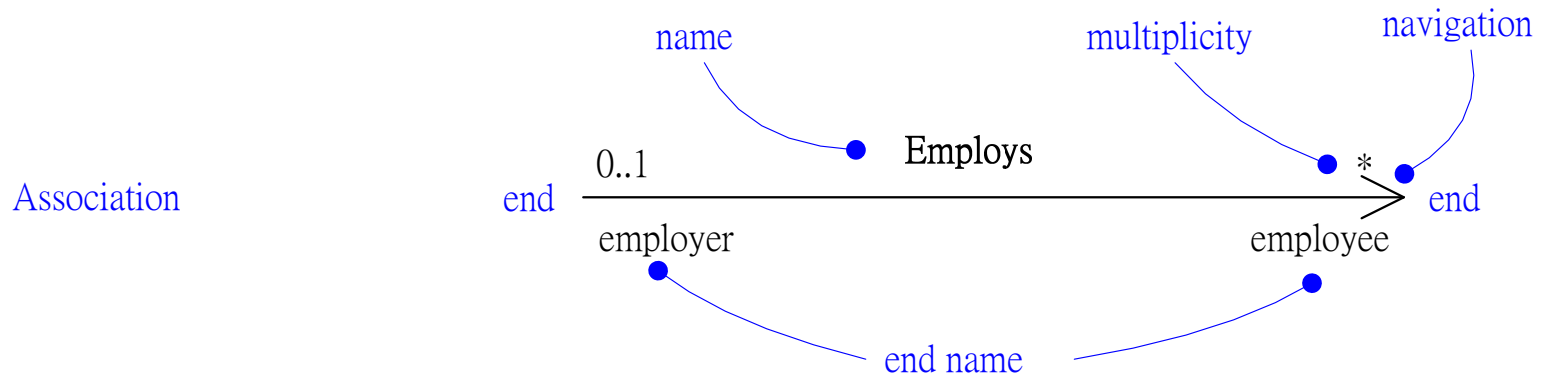
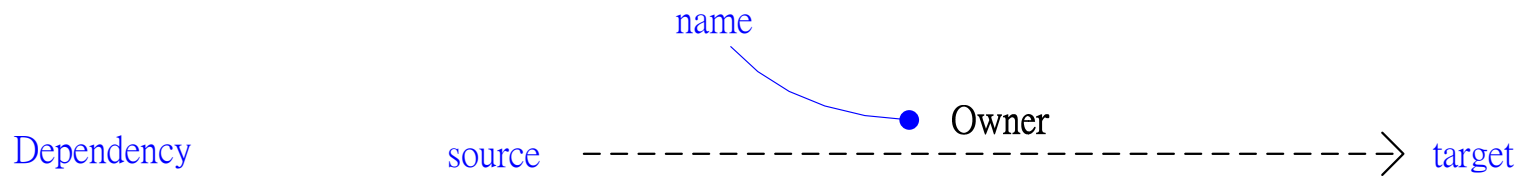

Note: direction of an association should now be indicated by a solid triangle ► following the association name.

Diagrams in the UML

- Graphical representations of **things** and **relationships**
- Structural and Architectural Diagrams:
 - **class** diagrams, **object** diagrams, **component** diagrams, **composite structure** diagrams, **deployment** diagrams (including artifact diagrams), **package** diagrams
- Behavioral Diagrams:
 - **use case** diagrams, **interaction** (sequence and communication) diagrams, **state** diagrams, **activity** diagrams, **timing** diagrams, **interaction overview** diagrams

Rules of the UML

- Well-formed models
 - Self-consistent
 - Following UML rules for names, scope, visibility, integrity, execution
- Not well-formed models
 - Elided: some elements hidden
 - Incomplete: some elements missing
 - Inconsistent

Common Mechanisms in the UML

- **Specifications:** textual statements behind every graphical element
- **Adornments**
 - unique notations for different elements/details
- **Common divisions**
 - class vs. object, interface vs. implementation, role vs. type
- **Extensibility mechanisms**
 - stereotypes, tagged values, constraints

Extensibility

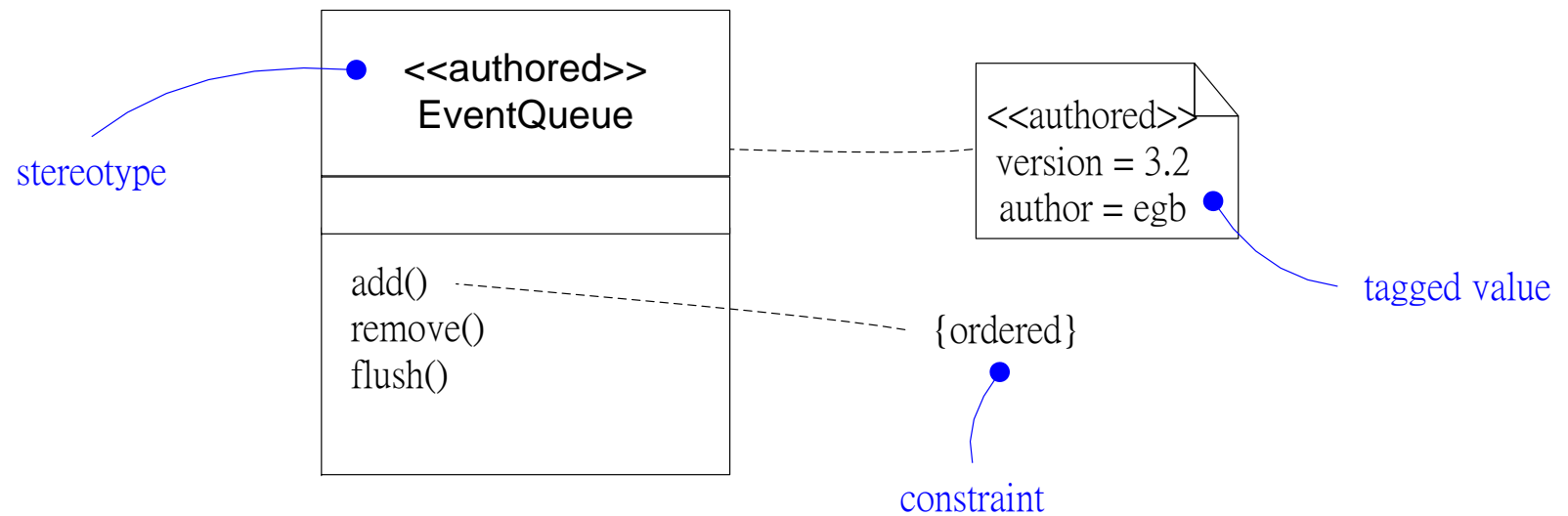

Class Diagram

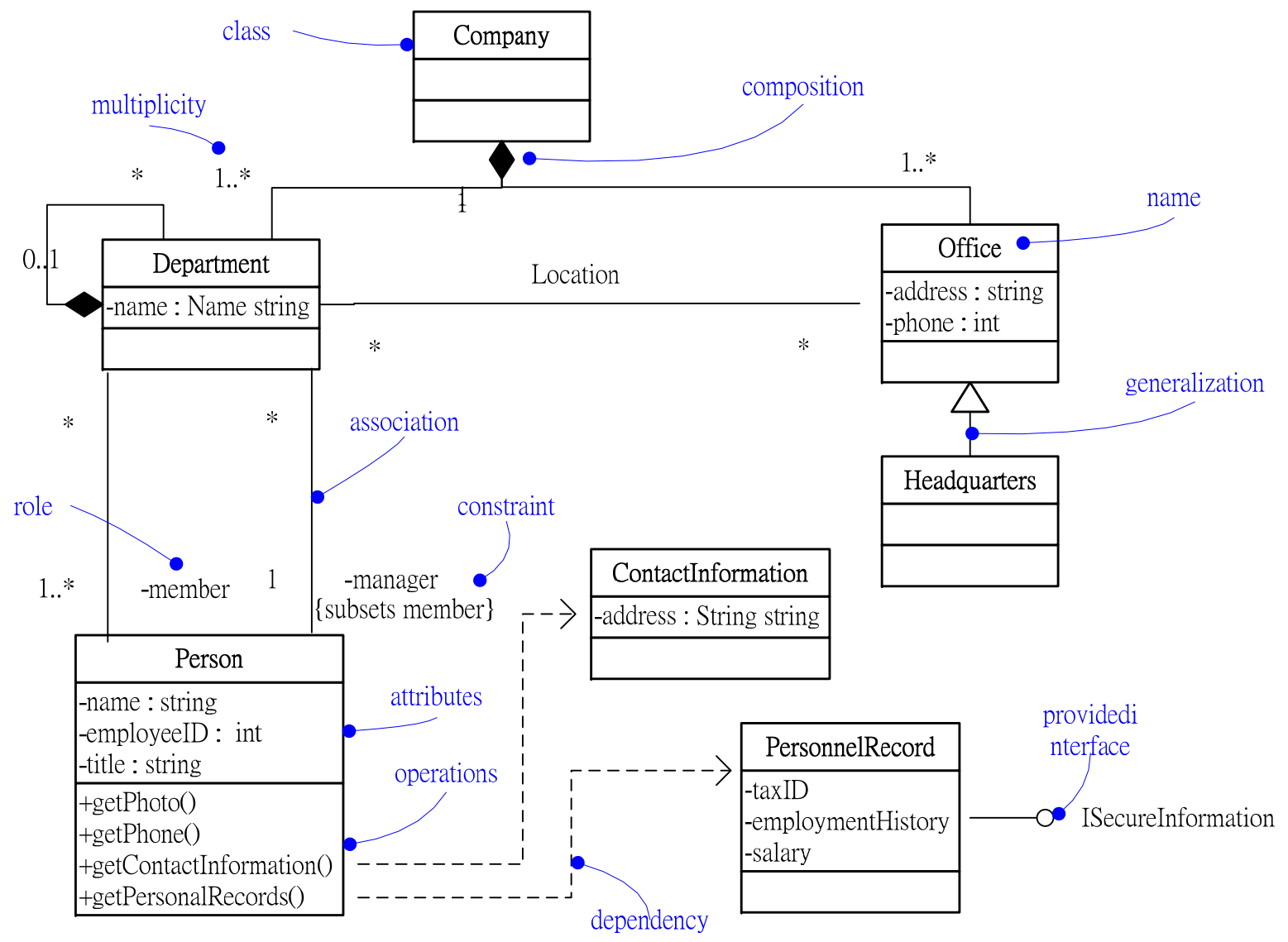

Sequence Diagram

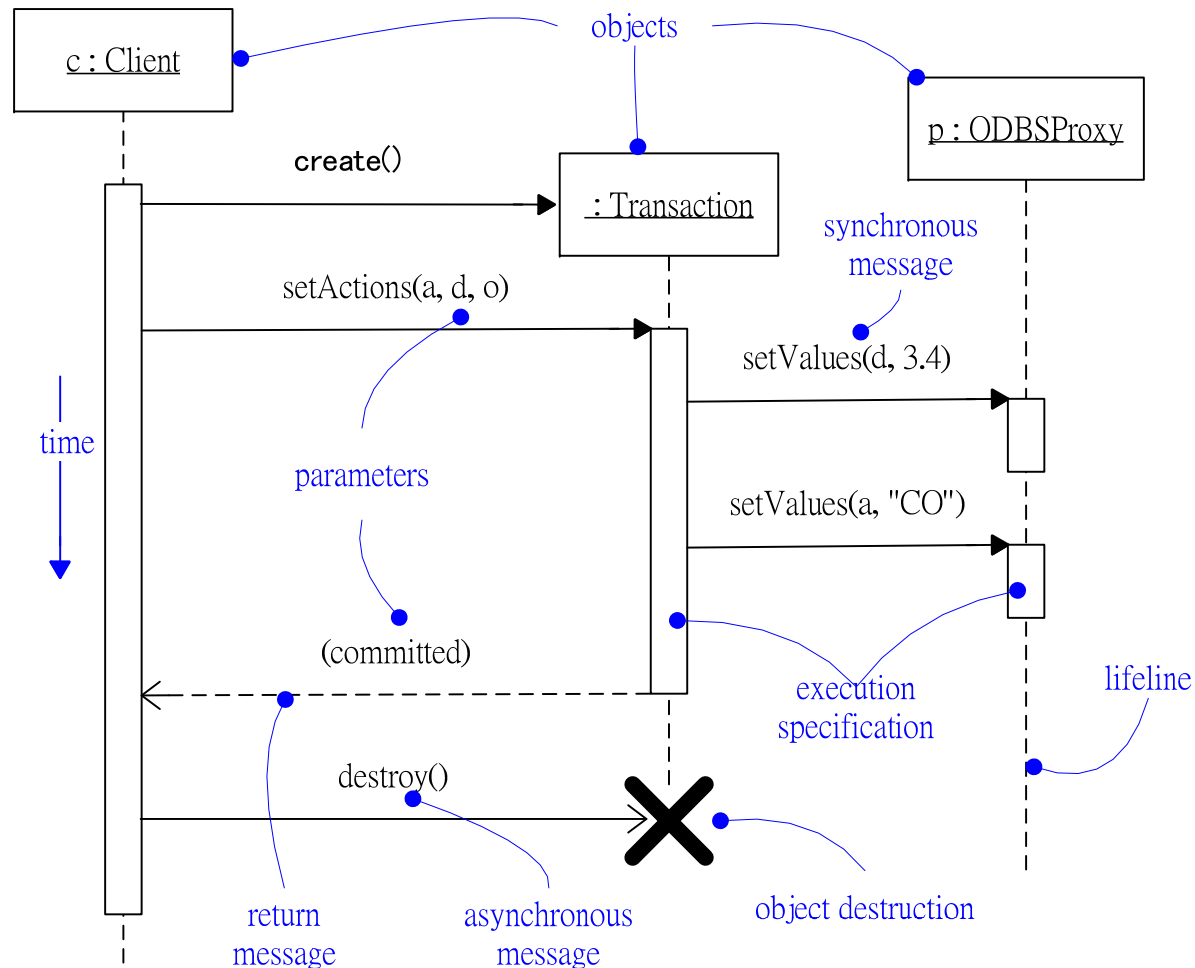

Use Case Diagram

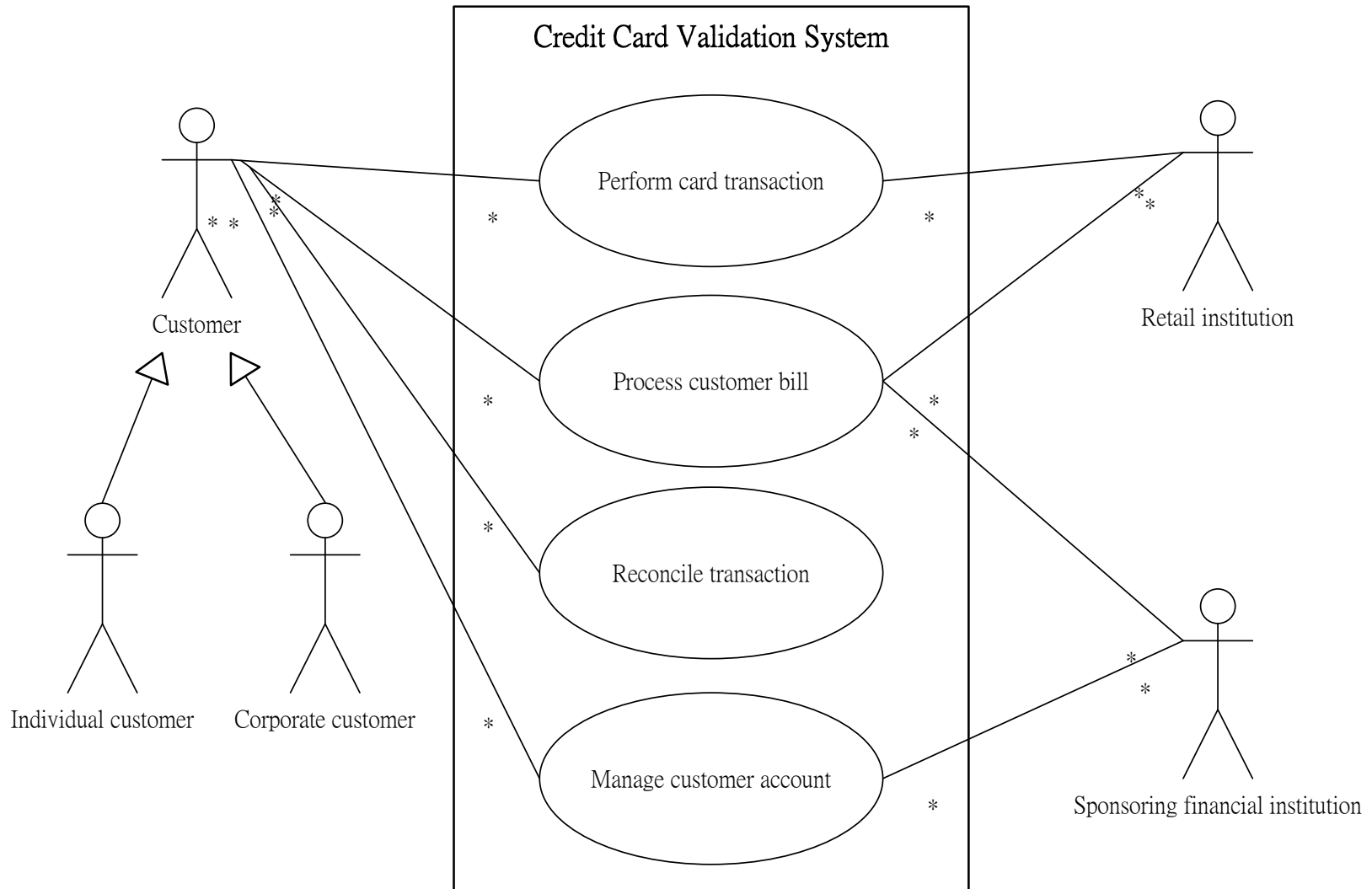

Remarks

- The best way to learn the UML is by actually using it:
 - Design patterns
 - Term project
- In follow-up lectures, we will cover
 - Basic structural and behavioral diagrams
 - Some more advanced UML features
 - The Object Constraint Language
- Things not covered in class are left for you to explore.